

■ BEMETA



stainless2023











Piktogramy

Pictograms

Piktogramm-Symbole

Графические символы

-  **Montáž na zeď**
Wall mounting/Wandmontage/Настенный монтаж
-  **Zabudovaný do zdi**
Built into the wall/In die Wand eingebaut
Встраиваемый в стену
-  **Volně stojící**
Freestanding/Freistehend/Отдельностоящий
-  **Manuální ovládání**
Manual control/Manuelle Kontrolle
Механическое управление
-  **Manuální ovládání pákou**
Manual lever control/Manuelle Hebelsteuerung
Механическое управление с рычагом
-  **Bezdotykové ovládání**
Touchless control/Berührungslose Steuerung
Бесконтактное управление
-  **Tekuté mýdlo**
Liquid soap/Flüssigseife/Жидкое мыло
-  **Dezinfekční gel**
Disinfectant gel/Desinfektionsgel
Дезинфицирующий гель
-  **Pěnové mýdlo**
Foam soap/Schaumseife/Пенное мыло
-  **Tekutá dezinfekce**
Liquid disinfection/Flüssige Desinfektion
жидкая дезинфекция
-  **S dávkovačem tekutého mýdla**
With liquid soap dispenser/Mit Flüssigseifenspender
С дозатором жидкого мыла

-  **Mat**
Mat/Gebürstet/Mat
-  **Lesk**
Polished/Poliert/Блеск
-  **Černý**
Black/Schwarz/черный
-  **Bílý**
White/Weiß/Белый
-  **Bronz**
Bronze/Bronze/Бронза
-  **Zrcadlo**
Mirror/Spiegel/Зеркало
-  **Zámek**
Lock/Sperren/Замок
-  **Bílý kartáč**
White brush/weiße Bürste/Белая щётка
-  **Černý kartáč**
Black brush/schwarze Bürste/черная щётка
-  **Produkt je opatřený lepicí páskou, nevrťtá se.**
The product is provided with adhesive tape,
it does not drill.
Das Produkt ist mit Klebeband ausgestattet,
bohrt nicht.
Изделие снабжено скотчем, без сверления.

Použitý materiál

Used material/Gebrauchtes Material/Используемый материал

304

Kartáčovaná nerez - základní materiál použitý k výrobě nerezových produktů. Určeno k vnitřnímu i venkovnímu použití v běžných podmínkách. Záruka 6 let za podmínek údržby uvedených v reklamačním řádu.

Brushed stainless steel - basic material used to manufacture stainless steel products. Intended for indoor and outdoor use in normal conditions.
6-year warranty under the maintenance conditions specified in the complaints procedure.

Gebürsteter Edelstahl - Grundmaterial zur Herstellung von Edelstahlprodukten. Zur Verwendung im Innen- und Außenbereich unter normalen Bedingungen vorgesehen. 6 Jahre Garantie unter den im Reklamationsverfahren angegebenen Wartungsbedingungen.

Шлифованная нержавеющая сталь марки 304 является основным материалом для производства изделий из нержавеющей стали. Предназначено для использования внутри и вне помещений в обычных климатических условиях.

Гарантийный срок 6 лет при условии соблюдения правил использования и обслуживания в соответствии с Порядком предъявления претензий.

316

NA OBJEDNÁVKU.

Kartáčovaná nerez - určená pro kontakt s chemickými látkami. Lze použít např. v plaveckých areálech, nereaguje na chlór.

ON ORDER.

Brushed stainless steel - intended for contact with chemical substances. Can be used e.g. in swimming areas, does not react to chlorine.

AUF BESTELLUNG.

Gebürsteter Edelstahl - bestimmt für den Kontakt mit chemischen Substanzen. Einsetzbar z.B. in Schwimmbädern, reagiert nicht auf Chlor.

НА ЗАКАЗ.

Шлифованная нержавеющая сталь марки 316 более устойчива к коррозии и агрессивным средам. Подходит для использования в бассейнах или в районах с морским климатом, т.к. невосприимчива к воздействию хлора и солям морской воды.

Obsah

Content

Inhalt

Содержание

DÁVKOVAČE MÝDLA/DEZINFEKCE	5	NEREZOVÉ DOPLŇKY	20
Soap/disinfectant dispensers		Stainless steel accessories	
Seifen-/Desinfektionsmittelspender		Edestahl Zubehör	
Дозаторы мыла/дезинфицирующего средства		Аксессуары из нержавеющей стали	
ZÁSOBNÍKY NA PAPIROVÉ KAPESNÍKY	7	Věšáčky na dveře	
Paper tissue dispensers		Hooks for door/Türhaken/Крючки на дверь	
Spender für Papiertaschentücher		Konzola pro umyvadlo uzavřená s držákem ručníků	
Диспенсеры для бумажных салфеток		Washbasin console, rectangular	
ZÁSOBNÍKY HYGIENICKÝCH SÁČKŮ	8	Konsole für Waschbeckenplatte	
HygBag		Кронштейн для умывальника	
HygBag-Spender		с полотенцедержателем	
Диспенсеры для гигиенических пакетов		Podstavec závěsný	
ZÁSOBNÍKY NA PAPIROVÉ RUČNÍKY	9	Hanging pedestal/Rahmen unter Waschtisch, hängend	
Hand towel dispensers		Каркас под столешницу	
Papierhandtuchspender		Sprchové poličky do spár	
Диспенсеры для бумажных полотенец		Shower shelves/Duschablagen	
ZÁSOBNÍKY NA TOALETNÍ PAPIR	10	Полочки для душа	
Toilet paper dispensers		Sprchové poličky	
Toilettenpapierspender		Shower shelves/Duschregale/Полочки для душа	
Диспенсеры для туалетной бумаги		Otvírák lahví	
DRŽÁKY TOALETNÍHO PAPIRU	11	Bottle opener/Flaschenöffner/Открывалка	
Toilet paper holders		Polička na ručníky pětipatrová	
Toilettenpapierhalter		Penta towel rack/5-fach Handtuchablage/	
Держатели туалетной бумаги		Настенный держатель полотенца	
WC ŠTĚTKY	12	Dveřní doraz na zem	
Toilet brushes		Door stop on floor/Bodentürstopper/Дверной упор	
WC-Bürsten		напольный	
Ёршики для унитаза		Dveřní doraz na zeď	
ZÁSTĚNY MEZI PISOÁRY	13	Door stop on wall/Wandtürstopper/Дверной упор	
Urinal partitions		настенный	
Urinal-Trennwände		Ikony	
Перегородки между писсуарами		Icons/Symbole/Таблички	
ODPAKOVÉ KOŠE	14	Sprchový program	
Waste bins		Shower program/Duschprogramm/Душевое	
Abfalleimer		оборудование	
Контейнеры для мусора		Niva	
BEZDOTYKOVÉ OSOUŠEČE RUKOU	18	Neo	
Automatic hand dryers		Easy	
Automatische Händetrockner		BEZBARIÉROVÉ BYDLENÍ - HELP PROGRAM	33
Автоматические сушилки для рук		Products for disabled people - HELP program	
ZRCADLA	19	Barrierefreies Wohnen - HELP-Programm	
Mirrors/		Безбарьерная среда - HELP программа	
Spiegel/		DESIGN NA ZAKÁZKU	36
Зеркала		Products on order	
		Maßgefertigtes Design	
		Индивидуальный дизайн	
		VESTAVNÉ WC BOXY	37
		Bathroom built-in unit	
		Badezimmer Wandeinbaumodule	
		Встраиваемые модули для туалета	
		VESTAVNÉ POLICE Z NERZOVÉ OCELI DO NIKY	34
		Built-in st. steel containers	
		Edelstahl Wandeinbaunische	
		Встраиваемые в нишу полки из нерж. стали	

Řadu NEREZ tvoří sortiment nepostradatelných koupelnových produktů, které se nesou v duchu maximálního minimalismu. Pokud hledáte designové doplňky splňující nejmodernější požadavky na vzhled i odolnost, s touto sérií vybavíte jakýkoliv prostor!

The STAINLESS series consists of an assortment of indispensable bathroom products, created in the spirit of maximal minimalism. If you're in search of high quality design accessories, which have meet the latest requirements for appearance and durability, then with this series you will be able to equip any bathroom space!

Produktlinie EDELSTAHL besteht aus einem Sortiment unverzichtbarer Badezimmerprodukte, welche im Geiste des maximalen Minimalismus geschaffen wurden. Wenn Sie Design-Accessoires suchen, die modernsten Anforderungen an Optik und Langlebigkeit gerecht werden, können Sie mit dieser Serie jeden Raum ausstatten!

Коллекция NEREZ представляет собой ассортимент товаров, необходимых для ваннх комнат, выполненных в духе максимального минимализма. Если вы ищете стильные аксессуары, отвечающие современным требованиям к внешнему виду и долговечности, с этой коллекцией вы сможете обустроить любое помещение!



Dávkovače mýdla/dezinfekce

Soap/disinfectant dispensers

Seifen-/Desinfektionsmittelspender

Дозаторы мыла/дезинфицирующего средства



101009415
123×336×115 mm



106109085
110×240×85 mm



123109013
123209013
100×320×110 mm



101109285
100×335×195 mm



101409171
100×320×110 mm



105109335
105109345
142×268×102 mm



124109265
124109335
140×235×102 mm



106109091
100×150×105 mm



	101009415	106109085	123109013	123209013	101109285	101409171	105109335	105109345	124109265	124109335	106109091
Instalace Installation/Installation/Установка											
Povrchová úprava Finish/Ausführung/Поверхность											
Ovládání Control/Kontrolle/Управление											
Médium Medium/Medium/Назначение	LS	LS	LS	LS	LS	LS	LS DG	FS	LS	LD	LS
Objem Volume/Volumen/Объем	1 100 ml	800 ml	1 100 ml	1 100 ml	1 000 ml	1 100 ml	1 100 ml	1 100 ml	1 200 ml	1 200 ml	500 ml
Zámek Lock/Sperren/Замок											
Napájení Power/Strom/ Питание											



105109020
105109025
97×150×93 mm



105109035
107×180×98 mm



105109075
125×210×110 mm



105109205
80×180×105 mm



105109015
240×140×150 mm



141109195
100×220×113



137209155
70×175×120 mm



151109015
125×240×100



152109371
110×212×72 mm



152109381
136×212×72 mm



	105109020	105109025	105109035	105109075	105109205	105109015	141109195	137209155	151109015	152109371	152109381
Instalace Installation/Installation/Установка											
Povrchová úprava Finish/Ausführung/Поверхность											
Ovládání Control/Kontrolle/Управление											
Médium Medium/Medium/Назначение											
Objem Volume/Volumen/Объем	500 ml	500 ml	850 ml	1 250 ml	1 500 ml	1 000 ml	700 ml	250 ml	350 ml	250 ml	2×250 ml
Zámek Lock/Sperren/Замок											
Napájení Power/Strom/Питание											

Zásobníky na papírové kapesníky

Paper tissue dispensers
 Spender für Papiertaschentücher
 Диспенсеры для бумажных салфеток



101003025
 273×123 ×78 mm



102303020
102303021
102303025
 250×130×75 mm



113103021
 300×160×60 mm



134203022
 200×120×110 mm



	101003025	102303020	102303021	102303025	113103021	134203022
Instalace Installation/Installation/Установка						
Povrchová úprava Finish/Ausführung/Поверхность						
Zámek Lock/Sperren/Замок						

Zásobníky hygienických sáčků

HygBag

HygBag-Spender

Диспенсеры для гигиенических пакетов



101403031
101403035
95×145×30 mm



101403091
101403094
101403095
120×240×32 mm



101403130
101403131
101403134
101403135
92×131×24 mm

101003215

252×138×88 mm

Zásobník hygienických rukavic

Disposable gloves dispenser

Handschuhspender

Диспенсер для одноразовых перчаток



	101403031	101403035	101403091	101403094	101403095	101403130	101403131	101403134	101403135	101003215
Instalace Installation/Installation/Установка										
Povrchová úprava Finish/Ausführung/Поверхность										

Zásobníky na papírové ručníky

Hand towel dispensers

Papierhandtuchspender

Диспенсеры для бумажных полотенец



101003045
265×192×120 mm



101003205
384×336×115 mm



101003235
265×192×120 mm
101003275
265×375×120 mm



101003245
298×448×124 mm



101003255
298×448×124 mm



101003265
400×455×140 mm



113103041
113103045
270×375×115 mm



113103030
113103031
113103035
270×265×115 mm



	101003045	101003205	101003235	101003275	101003245	101003255	101003265	113103041	113103045	113103030	113103031	113103035
Instalace Installation/Installation/Становка												
Povrchová úprava Finish/Ausführung/Поверхность												
Ovládání Control/Kontrolle/Управление												
Médium Medium/Medium/Назначение		LS					LS					
Objem Volume/Volumen/Объем		1 100 ml					1 100 ml					
Zámek Lock/Sperren/Замок												

Zásobníky na toaletní papír

Toilet paper dispensers
 Toilettenpapierspender
 Диспенсери для туалетной бумаги



101003225
 173×78×145 mm



101003165
 130×679×120 mm



148212051
148212055
 260×282×117 mm



148312081
148312085
 310×325×128 mm



148112050
148112051
148112055
 200×215×117 mm

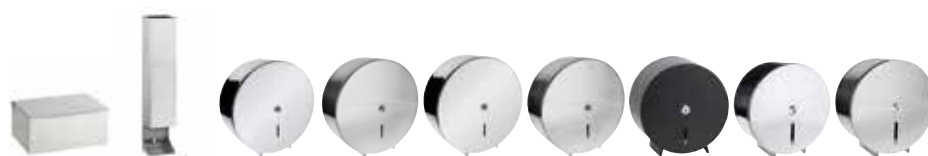

	101003225	101003165	148212051	148212055	148312081	148312085	148112050	148112051	148112055
Instalace Installation/Installation/Установка									
Povrchová úprava Finish/Ausführung/Поверхность									
Zámek Lock/Sperren/Замок									

Držáky toaletního papíru

Toilet paper holders
 Toilettenpapierhalter
 Держатели туалетной бумаги



101012175
 205×135×147 mm



101012015
 143×111×90 mm



101012185
 243×111×90 mm



105112315
 140×80/190×100 mm



146212011
 133×67×105 mm



153312132
 180×77×93 mm



101012045
 254×53×67 mm



146212245
 320×30×90 mm



105112121
 155×130×80 mm



134103012
 200×60×100 mm



	101012175	101012015	101012185	105112315	146212011	153312132	101012045	146212245	105112121	134103012
Instalace Installation/Installation/Установка										
Povrchová úprava Finish/Ausführung/Поверхность										

WC štětky

Toilet brush holders
WC-Bürsten
Ёршики для унитаза



101013175
148×448×129 mm



101113091
115×370×110 mm



101113335
110×400×115 mm



102313065
102313069
95×390×105 mm



102313075
102313079
90×380×115 mm



163113060
163113061
163113065
80×355×97 mm



	101013175	101113091	101113335	102313065	102313069	102313075	102313079	163113060	163113061	163113065
Instalace Installation/Installation/Установка										
Povrchová úprava Finish/Ausführung/Поверхность										
Kartáč Brush/Bürste/Щётка										

Zástěny mezi pisoáry

Urinal partitions

Urinal-Trennwände

Перегородки между писсуарами



101042065
60×860×400 mm



101042075
30×800×390 mm



	101042065	101042075
Instalace Installation/Installation/Установка		
Povrchová úprava Finish/Ausführung/Поверхность		

Odpadkové koše

Waste bins
Abfalleimer
Контейнеры для мусора



101015315

170×42×170 mm, ø 135 mm

Vhoz kulatý k zabudování do desky

Countertop-mounted circular waste chute

Durchwurfring zum Einbau

Люк для мусора круглый, встраиваемый



101015335

300×105×30 mm

Vhoz k zabudování do desky

Countertop-Mounted lid trash bin cover

Quadratischer Abfallschacht zum Einbau

Люк для мусора прямоугольный, встраиваемый



101015295

298×448×170 mm



101015305

298×448×170 mm



101015325

300×450×130 mm



101015345

226×570×130 mm



101015355

300×560×330 mm



105115055

190×265×90 mm



	101015315	101015335	101015295	101015305	101015325	101015345	101015355	105115055
Instalace Installation/Installation/Становка	■	■	■	■	■	■	■	■
Povrchová úprava Finish/Ausführung/Поверхность	■	■	■	■	■	■	■	■
Objem volume/Volumen/Объем			6,5 l	21 l	4 l	4 l	45 l	5 l
Vnitřní nádoba Inner container/Innenbehälter/Внутреннее ведро			✓	✓	✓	✓	✓	✓
Zásobník hygienických sáčků Storage of sanitary bags/Hygienebeutelspender/Хранение гигиенических пакетов			✓		✓	✓		



101915050
101915051
101915054
101915055
 205×300×100 mm



101915110
101915111
101915115
 250×500×250 mm



101915121
101915125
 300×600×250 mm



101915131
101915135
 350×750×250 mm



125115041
125115045
 370×460×165 mm

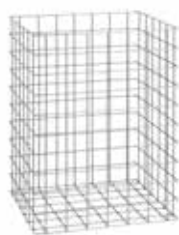

101015065
 353×503×305 mm



101015365
 455×603×255 mm



115115031
115115035
 200×270×200 mm



	101915050	101915051	101915054	101915055	101915110	101915111	101915115	101915121	101915125
Instalace Installation/Installation/Установка									
Povrchová úprava Finish/Ausführung/Поверхность									
Objem volume/Volumen/Объем	6 l	6 l	6 l	6 l	25 l	25 l	25 l	45 l	45 l
Vnitřní nádoba Inner container/Innenbehälter/ Внутреннее ведро	✓	✓	✓	✓					



	101915131	101915135	125115041	125115045	101015065	101015365	115115031	115115035
Instalace Installation/Installation/Установка								
Povrchová úprava Finish/Ausführung/Поверхность								
Objem volume/Volumen/Объем	75 l	75 l	25 l	25 l	52 l	67 l	9 l	9 l



125115051
125115055
170×235×240 mm



104315010
104315014
205×280×205 mm



104315023
170×260×170 mm



104315022
104315025
170×255×170 mm



104315012
104315052
200×280×200 mm



104315032
250×390×250 mm



104315082
300×450×300 mm



104315092
300×650×300 mm



	125115051	125115055	104315010	104315014	104315023	104315022
Instalace Installation/Installation/Становка						
Povrchová úprava Finish/Ausführung/Поверхность						
Objem volume/Volumen/Объем	3 l	3 l	5 l	5 l	3 l	3 l
Vnitřní nádoba Inner container/Innenbehälter/Внутреннее ведро						
Soft Close						



	104315025	104315012	104315052	104315032	104315082	104315092
Instalace Installation/Installation/Становка						
Povrchová úprava Finish/Ausführung/Поверхность						
Objem volume/Volumen/Объем	3 l	5 l	5 l	12 l	20 l	30 l
Vnitřní nádoba Inner container/Innenbehälter/Внутреннее ведро						



104315102
350×650×350 mm



125115071
200×300×200 mm



137115225
240×340×240 mm



137115205
120×155×120 mm



150115151
150115161
250×295×250 mm



137115215
450×755×430 mm



137115165
400×490×320 mm



104315262
590×435×375 mm



104315272
590×435×375 mm



	104315102	125115071	137115225	137115205	150115151	150115161	137115215	137115165	104315262	104315272
Instalace Installation/Installation/Установка	●	●	●	●	●	●	●	●	●	●
Povrchová úprava Finish/Ausführung/Поверхность	■	■	■	■	■	■	■	■	■	■
Objem volume/Volumen/Объем	40 l	6 l	9 l	1,5 l	7,5 l	7,5 l	90 l	2×15 l	3×14 l	2×20 l
Vnitřní nádoba Inner container/Innenbehälter/Внутреннее ведро		✓	✓					2× ✓	3× ✓	2× ✓
Soft Close		✓						✓	✓	✓
Povrch odolný proti otiskům prstů Fingerprint resistant / Fingerabdrucksichere Oberfläche/Защита от отпечатков пальцев			✓	✓			✓	✓	✓	✓

Bezdotykové osoušeče rukou

Automatic hand dryers

Automatische Händetrockner

Автоматические сушилки для рук



924224150
924224155

170×255×100 mm, 700 W



924224141

260×230×195 mm, 2300 W



106224015
945224061

270×240×200 mm, 2500 W



924224131
924224135

173×255×150 mm, 1350 W



924224121

295×320×162 mm, 1800 W



924224111

290×325×105 mm, 1000 W



	924224150	924224155	924224141	106224015	945224061	924224131	924224135	924224121	924224111
Instalace Installation/Installation/Установка									
Povrchová úprava Finish/Ausführung/Поверхность									
Jmenovitý příkon Rated power/Nennleistung/Номинальная мощность	1000 W	1000 W	2 300 W	2 500 W	2 500 W	1 350 W	1 350 W	1 800 W	1 000 W
Frekvence Frequency/Frequenz/Частота	50 Hz	50 Hz	50 Hz	50/60 Hz	50/60 Hz	50/60 Hz	50/60 Hz	50/60 Hz	50/60 Hz
Jmenovité napětí Feeding tension/Nennspannung/Номинальная мощность	230 V	230 V	220-240 V	220-240 V	220-240 V	220-240 V	220-240 V	220-240 V	220-240 V
Max. rychlost vzduchu max. air speed/Max. Luftgeschwindigkeit/Макс. скорость воздушного потока	100 m/s	100 m/s	26 m/s	30 m/s	30 m/s	100 m/s	100 m/s	100 m/s	100 m/s
Hlučnost Noise/Lärm/Уровень шума	70 dB	70 dB	70 dB	85 dB	85 dB	70 dB	70 dB	74 dB	70 dB
Třída izolace Insulation class/Isolationsklasse/Степень пылевлагозащиты	IP 23	IP 23	X1	IP 60	IP 60	X1	X1	X1	X1
Zapojení do zásuvky Connecting to a socket/Anschluss an eine Steckdose/Подключение к розетке	✓	✓	✓	✓	✓	✓	✓	✓	✓

Zrcadla

Mirrors
Spiegel
Зеркала



101301652
600×800 mm



301401041
301401042
301401044
600×600 mm



301401030
301401031
301401032
301401034
600×400 mm



	101301652	301401041	301401042	301401044	301401030	301401031	301401032	301401034
Instalace Installation/Installation/Установка								
Povrchová úprava Finish/Ausführung/Поверхность	SUPER							
Výklopné Tilting/Клоспиедл/Поверотно-стидный механизм								

Nerezové doplňky

Stainless steel accessories

Edestahl Zubehör

Аксессуары из нержавеющей стали

Věšáčky na dveře

Hook for door/Türhaken/Крючки на дверь



101106150
101106154
101106155
25×85×34 mm



101106220
101106224
101106225
175×87×34 mm



101106230
101106234
101106235
350×87×34 mm

Konzola pro umyvadlo uzavřená s držákem ručníků

Washbasin console, rectangular/Konsole für Waschbeckenplatte/Кронштейн для умывальника с полотенцедержателем

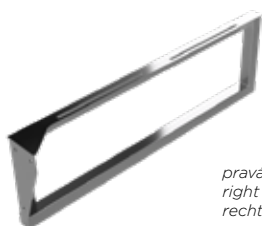

pravá
right
rechts
правый

201541060
201541061
201541064
201541065
56×150×490 mm, 50 kg



levá
left
links
левый

201541050
201541051
201541054
201541055
56×150×490 mm, 50 kg



101106150	101106154	101106230	201541060	201541061	201541064	201541065
101106220	101106224	101106225	201541050	201541051	201541054	201541055
101106230	101106234	101106235				
Povrchová úprava Finish/Ausführung/Поверхность	■	□	■	■	□	■

Podstavec závěsný

Hanging pedestal/Rahmen unter Waschtisch, hängend/Каркас под столешницу, подвесной

**Zakázková výroba.****Rozměr a povrchová úprava dle požadavků zákazníka**

Products on order.

Dimension and finish according to customer requirements

Kundenspezifische Produktion.

Dimension und Ausführung nach Kundenwunsch

Изготовление под заказ.

Размеры и поверхностная обработка по индивидуальному запросу заказчика.



Sprchové poličky do spár

Shower shelves/Duschablagen/Полочки для душа



101302400
101302401
101302405
 300×2×135 mm



101302410
101302411
101302415
 300×15×135 mm



101302420
101302421
101302425
 297×2×210 mm



101302430
101302431
101302435
 297×15×210 mm



101302440
101302441
101302445
 297×2×210 mm



101302450
101302451
101302455
 297×15×210 mm

Sprchové poličky

Shower shelves/Duschregale/Полочки для душа



102308080
102308081
 300×26×115 mm



102308051
 205×25×110 mm



102308260
102308261
102308264
 262×35×142 mm



102308061
 311×45×210 mm



101302400	101302401	101302405								
101302410	101302411	101302415								
101302420	101302421	101302425	102308080	102308081	102308051	102308260	102308261	102308264	102308061	
101302430	101302431	101302435								
101302440	101302441	101302445								
101302450	101302451	101302455								

Povrchová úprava
 Finish/Ausführung/Поверхность



Sprchové poličky

Shower shelves/Duschregale/Полочки для душа

**146208016**

305×55×220 mm

**146208036**

300×55×125 mm

**102308216**

315×67×235 mm

**153102390**

290×47×220 mm

**102308241**

305×380×115 mm

Otvírák lahví

Bottle opener/Flaschenöffner/Открывалка

**101832011**

45×65×40 mm

Polička na ručníky pětipatrováPenta towel rack/5-fach Handtuchablage
Настенный держатель полотенец**101302182**

150×265×120 mm

Dveřní doraz na zemDoor stop on floor/Bodentürstopper/Дверной упор
напольный**101218010****101218012****101218015****101218017**

33×30×33 mm

Dveřní doraz na zeďDoor stop on wall/Wandtürstopper/Дверной упор
настенный**101218020****101218022****101218025****101218027**

33×30×33 mm



146208016

146208036

102308216

153102390

102308241

101832011

101302182

101218010
101218020101218012
101218022101218015
101218025101218017
101218027Povrchová úprava
Finish/Ausführung/Поверхность

Ikony

Icons/Symbole/Таблички



111022062
111022065

120×120×2 mm

Přebalovna

Baby nursery room

Wickelraum

Помещение для
переодевания детей



111022012
111022015

120×140×2 mm

Kouření povoleno

Smoking

Rauchen gestattet

Место для курения



111022052
111022055

120×140×2 mm

Zákaz kouření

No smoking

Rauchen verboten

Курить запрещено



111022032
111022035

120×130×2 mm

WC páni

Gentlemen toilet

WC Herren

Мужской туалет



111022042
111022045

120×130×2 mm

WC dámy

Ladies toilet

WC Damen

Женский туалет



111022022
111022025

120×130×2 mm

WC vozíčkář

Disabled toilets

Behinderte

Туалет для инвалидов



111022082
111022085

120×120×2 mm

WC

WC

WC

WC



111022072
111022075

120×120×2 mm

Sprcha

Showers

Duschen

Душевая



111022092
111022095

120×120×2 mm

Úklidová místnost

Cleaning room

Putzraum

Подсобное помещение



108022072
108022075

80×35×2 mm

WC

WC

WC

WC



108022062
108022065

40×85×2 mm

WC dámy

Ladies toilet

WC Damen

Женский туалет



108022052
108022055

40×85×2 mm

WC páni

Gentlemen toilet

WC Herren

Мужской туалет

	Povrchová úprava Finish/Ausführung/Поверхность	Instalace Installation/Installation/Установка
XXXXXXXX-2		
XXXXXXXX-5		

Ikony

Icons/Symbole/Таблички

**111054003 - A**

75×75×2 mm

Přebalovna

Baby nursery room

Wickelraum

Помещение для
переодевания детей**111054021 - A**

75×75×2 mm

Kouření povoleno

Smoking

Rauchen gestattet

Место для курения

**111054022 - A**

75×75×2 mm

Zákaz kouření

No smoking

Rauchen verboten

Курить запрещено

**111054002 - A**

75×75×2 mm

WC páni

Gentlemen toilet

WC Herren

Мужской туалет

**111054007 - A**

75×75×2 mm

WC dámy

Ladies toilet

WC Damen

Женский туалет

**111054072 - A**

75×75×2 mm

Ženy a muži

Man and woman

Damen und Herren

Для мужчин
и женщин**111054001 - A**

75×75×2 mm

WC vozíčkář

Disabled toilets

Behinderte

Туалет для
инвалидов**111054006 - A**

75×75×2 mm

WC

WC

WC

WC

**111054004 - A**

75×75×2 mm

Sprcha

Showers

Duschen

Душевая

**111054005 - A**

75×75×2 mm

Úklidová místnost

Cleaning room

Putzraum

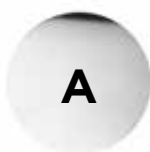
Подсобное
помещение**kruh, lesk**
circle, polished
rund, glänzend
круг, блеск**čtverec, lesk**
square, polished
quadratisch, glänzend
квадрат, блеск**kruh, mat**
circle, matt
rund, matt
круг, мат**čtverec, mat**
square, matt
quadratisch, matt
квадрат, мат**Instalace**
Installation/Installation/Установка

A, B, C, D

**Kompletní nabídka informačních tabulek: www.bemeta.cz**Complete offer of icons: [www.bemeta.cz/Komplettes Angebot an Informationstafeln](http://www.bemeta.cz/Komplettes>Angebot an Informationstafeln): www.bemeta.cz/Полное предложение информационных табличек: www.bemeta.cz.

Sprchový program

Shower program/Duschprogramm/Душевое оборудование



101114361

ø 25 mm, 900×55×55 mm

101120012

ø 25 mm, 1 000×55×55 mm

101120022

ø 25 mm, 1 500×55×55 mm

101120032

ø 25 mm, 2 000×55×55 mm

Tyč sprchového závěsu*

Shower curtain holder*

Duschvorhangstange*

Карниз для душа*



101120042

ø 25 mm, 900×500×900 mm

101120052

ø 25 mm, 1 400×500×1 400 mm

Tyč sprchového závěsu, rohová*

Shower curtain holder, corner model*

Eckduschvorhangstange*

Угловой карниз для душа*



101120071

ø 25 mm, 900×60×60 mm

101120081

ø 25 mm, 1 000×60×60 mm

101120091

ø 25 mm, 1 500×60×60 mm

101120101

ø 25 mm, 2 000×60×60 mm

Tyč sprchového závěsu, skládaná*

Shower curtain holder, folding*

Duschvorhangstange, steckbar*

Карниз для душа, разборный*



101120111

ø 25 mm, 900×500×900 mm

101120231

ø 25 mm, 1 300×500×1 300 mm

101120121

ø 25 mm, 1 400×500×1 400 mm

Tyč sprchového závěsu rohová, skládaná*

Shower curtain holder, corner model, folding*

Duschvorhangstange steckbar*

Угловой карниз для душа, разборный*



101120110

ø 25 mm, 900×500×900 mm

Tyč sprchového závěsu rohová, skládaná*

Shower curtain holder, corner model, folding*

Duschvorhangstange steckbar*

Угловой карниз для душа, разборный*

* Tyče dodáváme bez sprchového závěsu.

* The rods are supplied without a shower curtain./Die Stange liefern wir ohne Duschvorhang.
Занавеска для душа в комплект не входит.

Sprchový program

Shower program/Duschprogramm/Душевое оборудование

Objednejte si skládanou tyč sprchového závěsu na míru

Assemble your custom shower curtain holder from our components.

Bestellen Sie steckbare Duschvorhangstange, wunschgemäß angepasst.

Вы можете заказать карниз для душа, составленный из необходимых элементов

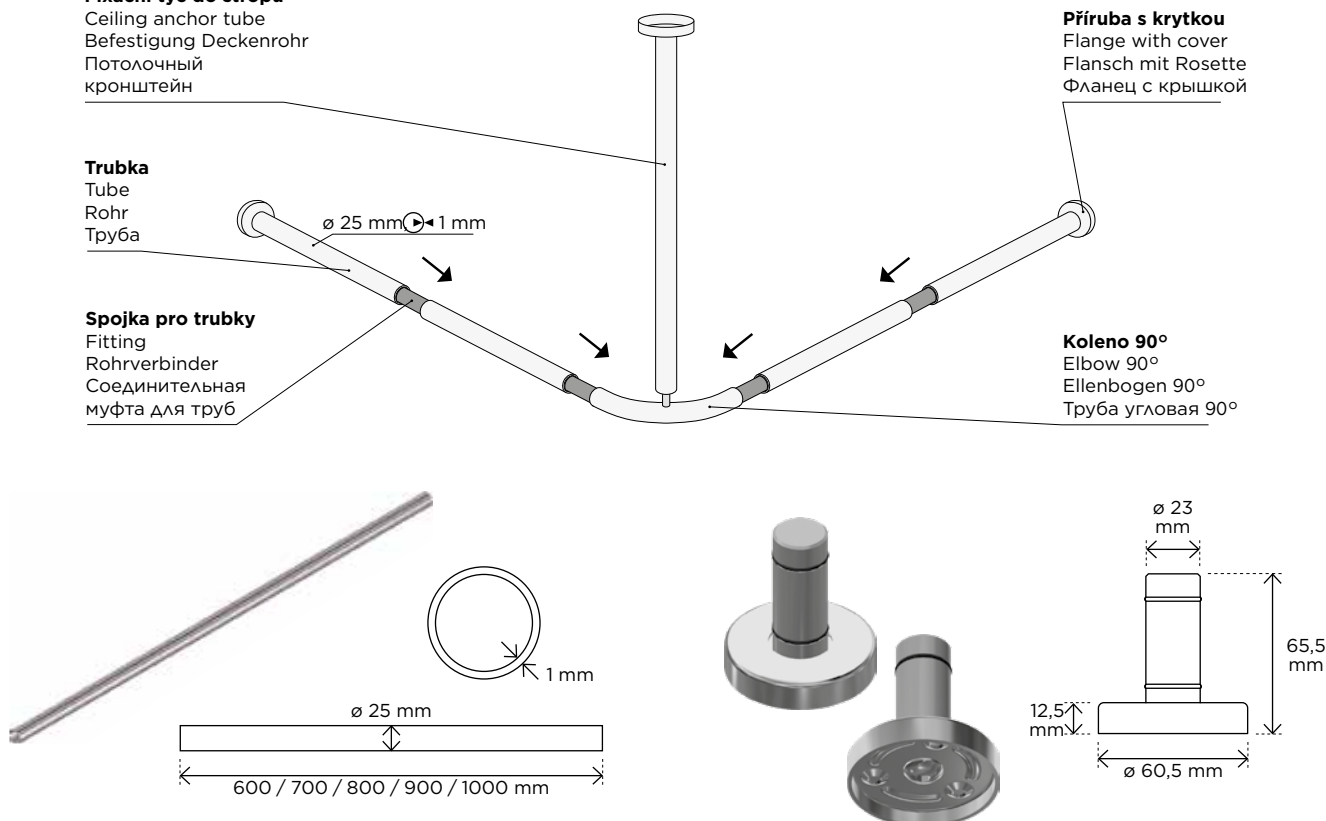
Fixační tyč do stropuCeiling anchor tube
Befestigung Deckenrohr
Потолочный кронштейн**Trubka**Tube
Rohr
Труба**Spojka pro trubky**Fitting
Rohrverbinder
Соединительная муфта для труб**Příruba s krytkou**Flange with cover
Flansch mit Rosette
Фланец с крышкой**Koleno 90°**Elbow 90°
Ellenbogen 90°
Труба угловая 90°

Trubka	
Tube/Rohr/Труба	
600 mm	101120162
700 mm	101120172
800 mm	101120182
900 mm	101120192
1000 mm	101120202
1170 mm	101120271

101120132**Příruba s krytkou, včetně montážního balíčku**

Flange with cover, including assembly package

Flansch mit Rosette, inkl. Montagepaket

Фланец с крышкой, вкл. крепёж

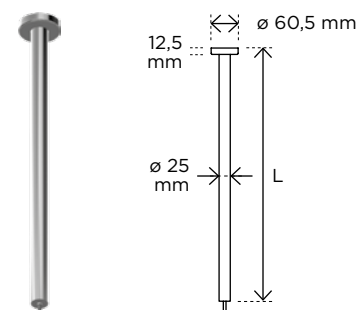
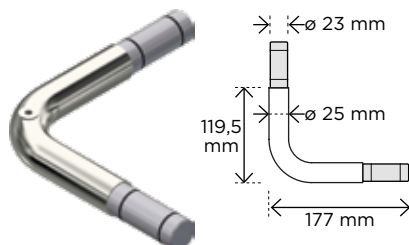
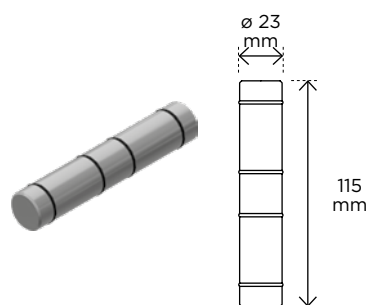
**101120152****Spojka pro trubky**

Fitting

Rohrverbinder

Соединительная муфта для труб

101120222**Koleno 90° + 2× spojka**

Elbow 90° + 2× fitting

Ellenbogen 90° + 2× Rohrverbinder

Труба угловая 90°
+ 2× Соединительная муфта**Fixační tyč do stropu**Ceiling anchor tube/Befestigung
Deckenrohr/Потолочный
кронштейн300 mm **101120241**500 mm **101120142**800 mm **101120251**1200 mm **101120261**

NIVA



101106035

48×85×22 mm

Háček dvojitý

Double robe hook

Doppelkleiderhaken

Крючок двойной



101106045

180×70×22 mm

Věšák s 5 háčky

Hanger, 5 hooks

Hakenleiste mit 5 Haken

Планка с 5 крючками



101106025

155×57×80 mm

Držák toaletního papíru

Paper holder

Papierrollenhalter

Держатель туалетной бумаги



101104015

270×57×80 mm

Držák toaletního papíru s poličkou

Toilet paper holder with shelf

Toilettenpapierhalter mit Ablage

Держатель туалетной бумаги с полочкой



101102365

180×50×97 mm

Polička

Shelf

Handtuchablage

Полочка



101102225

300×50×97 mm

Polička

Shelf

Handtuchablage

Полочка



101112135

335×50×70 mm

Držák ručníků

Towel holder

Handtuchhalter

Полотенцедержатель



101109225

66×165×120 mm, 300 ml

Dávkovač mýdla

Soap dispenser

Seifenspender

Дозатор мыла



101109095

66×235×120 mm, 500 ml

Dávkovač mýdla

Soap dispenser

Seifenspender

Дозатор мыла



101113091

130×353×120 mm

WC štětka na zavěšení

Wall mounted toilet brush holder

WC - Bürstengarnitur hängend

Ёршик подвесной

Neo

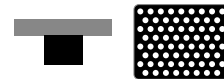

104106065

55×55×55 mm

Háček

Single robe hook

Kleiderhaken

Крючок



104106025

55×55×50 mm

Háček

Single robe hook

Kleiderhaken

Крючок



104106035

55×55×50 mm

Háček dvojitý

Double robe hook

Doppelkleiderhaken

Крючок двойной



104106165

ø 16×50 mm

104506095

ø 16×30 mm

Háček

Single robe hook

Kleiderhaken

Крючок



104112015

135×155×90 mm

Držák toaletního papíru s krytem

Paper holder with cover

Papierrollenhalter mit Deckel

Держатель туалетной бумаги с крышкой



104112045

135×120×98 mm

Držák toaletního papíru bez krytu

Paper holder without cover

Papierrollenhalter ohne Deckel

Держатель туалетной бумаги без крышки

levý
left
links
левый



104112045R

135×120×98 mm

Držák toaletního papíru bez krytu

Paper holder without cover

Papierrollenhalter ohne Deckel

Держатель туалетной бумаги без крышки

pravý
right
rechts
правый



104212035

175×55×70 mm

Držák toaletního papíru

Paper holder

Papierrollenhalter

Держатель туалетной бумаги



104112035

55×165×65 mm

Držák toaletního papíru rezervní

Spare toilet paper holder

Reservepapierrollenhalter

Держатель запасного рулона



104113105*

104113109**

110×400×130 mm

WC štětka na postavení

Toilet brush holder, free standing

WC-Bürstengarnitur mit Glasbehälter, Standmodell

Ёршик напольный



104113015*

104113019**

115×360×130 mm

WC štětka

Wall mounted toilet brush holder

WC-Bürstengarnitur mit Glasbehälter

Ёршик подвесной



102313075*

102313079**

90×380×115 mm

WC štětka

Wall mounted toilet brush holder

WC-Bürstengarnitur

Ёршик подвесной



102313055*
102313059**

95×380×95 mm

WC štětka na postavení

Toilet brush holder,
free standing

WC-Bürstengarnitur,
stehend oder hängend

Ёршик напольный



102313065*
102313069**

95×390×105 mm

**WC štětka na postavení
nebo pověšení**

Toilet brush holder,
free standing or hanging

WC-Bürstengarnitur,
stehend oder hängend

Ёршик
подвесной/напольный



104109115

75×145×100 mm, 200 ml

Dávkovač mýdla

Soap dispenser

Seifenspender

Настенный дозатор мыла



104109016

80×190×133 mm, 230 ml

Dávkovač mýdla

Soap dispenser

Seifenspender

Настенный дозатор мыла



104109015

55×175×85 mm, 150 ml

Dávkovač mýdla

Soap dispenser

Seifenspender

Настенный дозатор мыла



104109035

70×230×110 mm, 550 ml

**Dávkovač tekutého mýdla
JUMBO**

Soap dispenser JUMBO

Seifenspender JUMBO

Настенный дозатор мыла
JUMBO



123209013

100 × 320 × 110 mm, 1
100 ml

Dávkovač mýdla

Soap dispenser

Seifenspender

Диспенсер мыла



104106153

20 × 70 × 40 mm

Háček na dveře

Robe hook

Türhaken

Крючок на дверь



104308172

230×30×130 mm

Polička do sprchy rohová

Corner shower shelf

Eckduschkorb

Душевая полочка,
угловая



104308072

230×30×120 mm

Polička do sprchy

Shower shelf

Duschregal

Душевая полка



102307015

355 × 55 × 75 mm

Madlo

Bath grab bar

Wannengriff

Поручень прямой

**104204105**

55×165×440 mm

Držák ručníků dvojitý otočný

Double swing arm towel holder

Doppelhandtuchhalter, schwenkbar

Полотенцедержатель двойной поворотный

**104205075**

655×110×215 mm

Polička na ručníky s hrazdou

Towel rack with rail

Handtuchablage

Полочка для полотенец с вешалкой

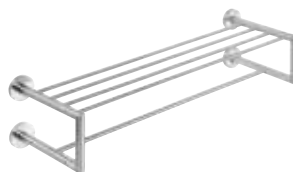
**104205105**

655×160×225 mm

Polička na ručníky dvojitá s hrazdou

Double towel rack with rail

Doppelhandtuchablage

Полочка для полотенец с вешалкой

**104204015**

355×55×65 mm

104204125

505×55×65 mm

104204125

655×55×65 mm

Držák ručníků

Towel holder

Handtuchhalter

Полотенцедержатель

**104204055**

655×55×125 mm

Držák ručníků dvojitý

Double towel holder

Doppelhandtuchhalter

Полотенцедержатель





easy



163106260 
163106261 
163106265 
 45×45×38 mm
Háček
 Single robe hook
 Kleiderhaken
 Крючок





163106360 
163106361 
163106365 
 45×45×31 mm
Háček
 Single robe hook
 Kleiderhaken
 Крючок



163106270 
163106271 
163106275 
 115×45×38 mm
Věšák se 2 háčky
 Hanger with 2 hooks
 Hakenleiste mit 2 Haken
 Планка с 2 крючками



163106370 
163106371 
163106375 
 115×45×31 mm
Věšák se 2 háčky
 Hanger with 2 hooks
 Hakenleiste mit 2 Haken
 Планка с 2 крючками



163106290 
163106291 
163106295 
 45×45×38 mm
Věšák se 4 háčky
 Hanger with 4 hook
 Hakenleiste mit 4 Haken
 Планка с 4 крючками



163106390 
163106391 
163106395 
 45×45×31 mm
Věšák se 4 háčky
 Hanger with 4 hook
 Hakenleiste mit 4 Haken
 Планка с 4 крючками



163112220 
163112221 
163112225 
 145×100×42 mm
Držák toaletního papíru
 Toilet paper holder
 Papierrollenhalter
 Держатель туалетной бумаги



163112020 
163112021 
163112025 
 145×100×42 mm
Držák toaletního papíru
 Toilet paper holder
 Papierrollenhalter
 Держатель туалетной бумаги



163112230 
163112231 
163112235 
 45×180×74 mm
Držák toaletního papíru rezervní
 Spare toilet papare holder
 Papierrollenhalter
 Держатель запасного рулона









163112030 
163112031 
163112035 
 45×180×74 mm
Držák toaletního papíru rezervní
 Spare toilet papare holder
 Papierrollenhalter
 Держатель запасного рулона



163113060 
163113061 
163113065 
 80×355×97 mm
WC štětka
 Wall mounted toilet brush holder
 WC-Bürstengarnitur
 Ёршик подвесной



163104040 
163104041 
163104045 
163104240 
163104241 
163104245 
 80×355×97 mm
Držák ručníků
 Towel holder
 Handtuchhalter
 Полотенцедержатель



Bezbariérové bydlení - HELP program

Products for disabled people - HELP program
 Barrierefreies Wohnen - HELP-Programm
 Безбарьерная среда - HELP программа

Možnosti provedení

Design possibilities/Ausführungsmöglichkeiten/Возможности изготовления

Povrchová úprava

Surface finish/Ausführung/Поверхность

lesk

polished/poliert/глянец



brus

brushed/gebürstet/шлиф



komaxit bílý

white/weiss/белый



komaxit černý

black/Schwarz/черный



Příruba s krytkou

Flange with cover/Flansch mit Rosette/Фланец с крышкой



Příruba bez krytky

Flange without cover/Flansch ohne Rosette/Фланец без крышки



Produkty

Products/Produkte/Продукты

Madlo

Grab bar/Haltegriff/поручень

200 mm	600 mm	1000 mm
300 mm	700 mm	1100 mm
400 mm	800 mm	1200 mm
500 mm	900 mm	1500 mm



Podpěrné madlo ve tvaru U

Grab bar U-shaped/Stützgriff

U-Förmig/Опорный U-образный

поручень
 600 mm 850 mm
 750 mm 900 mm
 813 mm



Podpěrné madlo ve tvaru U s držákem toaletního papíru

Grab bar U-shaped with toilet

paper holder/Stützgriff U-Förmig

mit Toilettenpapierhalter/Опорный U-образный поручень с держателем туалетной бумаги

600 mm 850 mm
 750 mm 900 mm
 813 mm



Sklopný úchyt ve tvaru U

Folding grab bar U-shaped/

Stützklappgriff/Откидной

U-образный поручень

600 mm 850 mm
 750 mm 900 mm
 813 mm



Sklopný úchyt ve tvaru U s držákem toaletního papíru

Folding grab bar U-shaped with

toilet paper holder/Stützklappgriff

mit Toilettenpapierhalter/Откидной

U-образный поручень с держателем туалетной бумаги

600 mm 850 mm
 750 mm 900 mm
 813 mm



Sklopný úchyt

Folding grab bar/Stützklappgriff/
Откидной поручень

760 mm
850 mm



Sklopný úchyt s držákem toaletního papíru

Folding grab bar with toilet
paper holder/Stützklappgriff mit
Toilettenpapierhalter/Откидной
поручень с держателем туалетной
бумаги

760 mm
850 mm



Sklopný úchyt ve tvaru U, ukotvený do země

Folding grab bar U-shaped, ground
mounted/Stützklappgriff U-Förmig,
Bodenmontage/Откидной
U-образный поручень, с креплением
к полу

750 mm
813 mm
850 mm



Sklopný úchyt ve tvaru U s opěrnou nohou

Folding grab bar U-shaped with
supporting leg/Stützklappgriff
U-Förmig mit Standfuss/Откидной
U-образный поручень с опорной
ножкой

600 mm 813 mm
750 mm 850 mm



Sklopný úchyt ve tvaru U s opěrnou nohou s držákem toaletního papíru

Folding grab bar U-shaped
with supporting leg with toilet
paper holder/Stützklappgriff
in U-Förmig mit Standfuss mit
Toilettenpapierhalter/Откидной
U-образный поручень с опорной
ножкой и держателем туалетной
бумаги

600 mm 813 mm
750 mm 850 mm



Úhlové madlo 120°

Angled grab bar 120°/
Winkelgriff 120°/
Угловой поручень 120°
660×400 mm



Nástěnné opěrné držadlo*

Shower grab bar*/Haltegriff*/
Поручень для душа*

680 mm
890 mm



Madlo do sprchy se svislou opěrou*

Shower grab bar*/Duschgriff mit glatter senkrechter Stütze*/Поручень для душа*

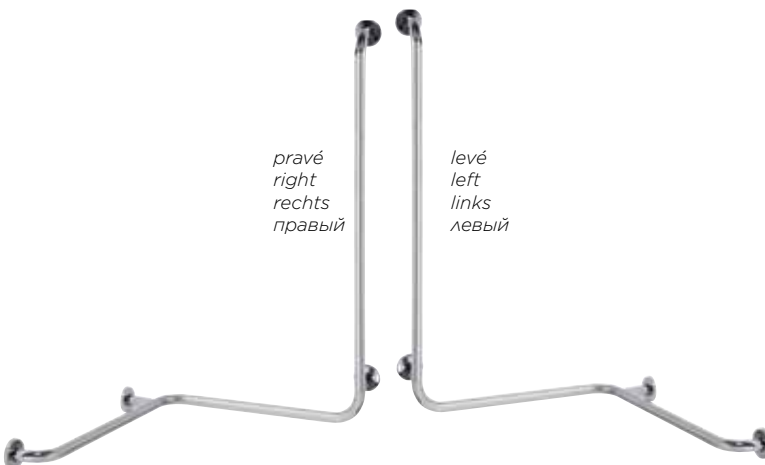

Opěrné madloGrab bar/Stützgriff/
Опорный поручень**Madlo do sprchy**Shower grab bar/Duschgriff/
Поручень для душа**Podpěrné madlo**Grab bar/Stützgriff/Опорный
поручень

500 mm

760 mm

**Sklopné sprchové sedátko**Reversible shower seat/
Duschklappsitz/
Откидное сиденье для душа**Sprchové sedátko**

Shower seat/Duschsitz/Сиденье для душа

**Kompletní nabídka programu HELP: katalog BEMETA HELP, www.bemeta.cz**The complete offer of the HELP program: catalogHELP, www.bemeta.comDas komplette Angebot des HELP-Programms: Katalog HELP, www.bemeta.comПолное предложение программы HELP: каталог HELP, www.bemeta.com

Design na zakázku

Custom design

Maßgefertigtes Design

Индивидуальный дизайн

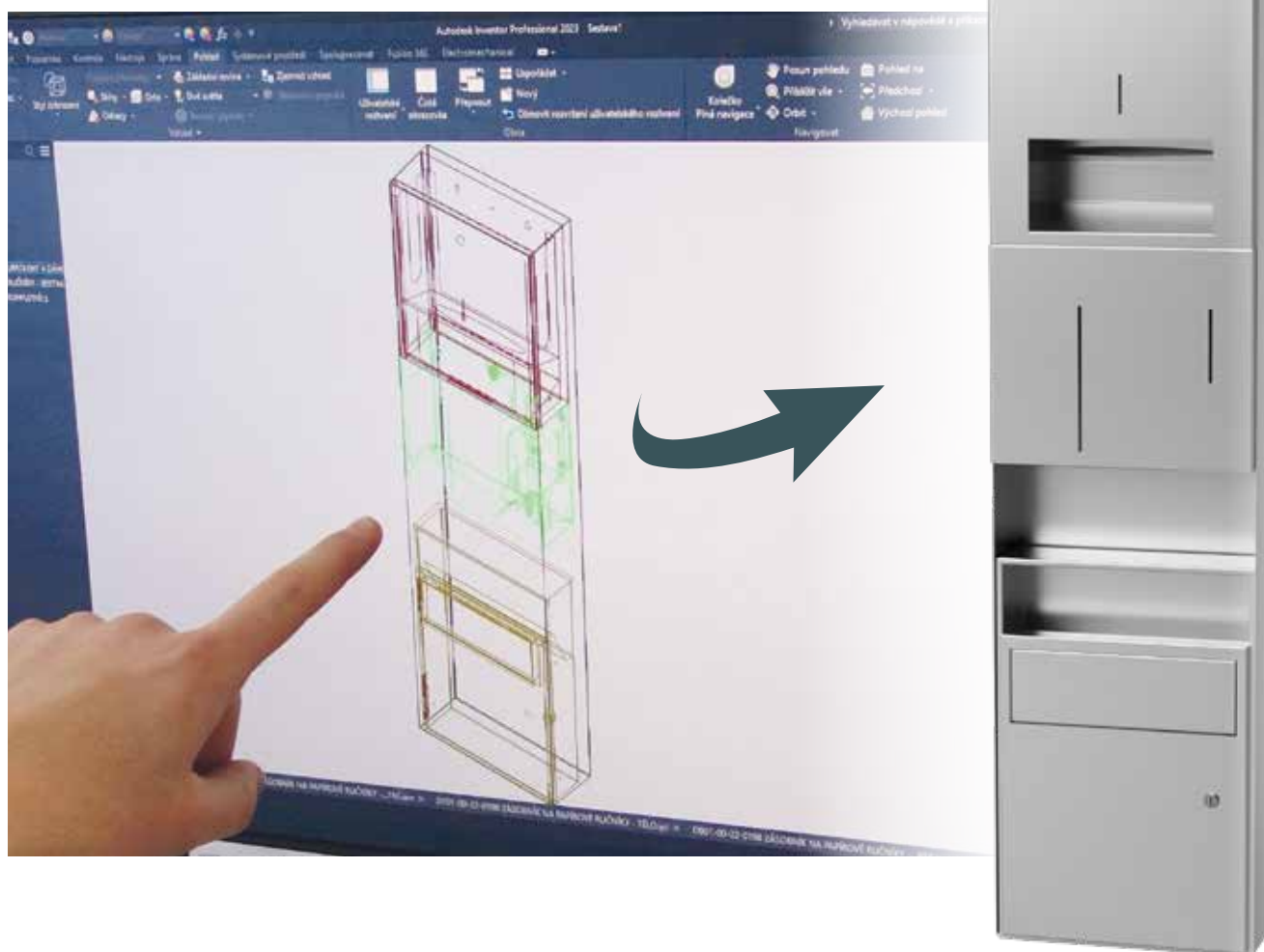

Přesné individuální přizpůsobení, speciální provedení.

I tyhle věci umíme! K doplnění našeho standardního sortimentu nabízíme speciální zákaznická řešení: přizpůsobení stávajících produktů i vytvoření zcela nových výrobků dle návrhu zákazníka a to vše během krátké doby. Toto vše může Bemeta nabídnout díky vlastní výrobě a týmu zkušených konstruktérů.

Accurate individual customized, special designs.

We can do ther things, too! To supplement our standard range, we offer special customer solutions: product adaptations as well as completely new designs from one source and within a short time, form sketch to finished product - thanks to in-house design and production in Reutlinge.

Präzise individuell angepasst, Sonderanfertigungen.

Das können wir auch! Ergänzend zu unserem Standardsortiment bieten wir spezielle Kundenlösungen: Produktanpassungen sowie komplette Neukonstruktionen aus einer Hand und innerhalb kurzer Zeit von der Formskizze zum fertigen Produkt - dank eigener Konstruktion und Fertigung in Reutlinge.

Индивидуальный подход и нестандартные решения.

Это тоже в наших силах! Дополнительно к стандартному ассортименту продукции мы предлагаем неординарные решения и создание совершенно новых продуктов по желанию заказчика. Все это - благодаря собственному производству и команде опытных дизайнеров.

Vestavné WC boxy

Bathroom built-in unit

Badezimmer Wandeinbaumodule

Встраиваемые модули для туалета



PLATE

Vestavný wc box z nerezové oceli na štětku a toaletní papír

Built-in Stainless steel container for toilet brush and toilet roll

WC Edelstahl Wandeinbaumodule mit Bürstengarnitur und Papierrollenhalter

Встраиваемый модуль для туалета



Typ oceli:
Steel grade:
Stahlsorte:
Тип стали:

- | | |
|-----------|---|
| SB | Kartáčovaná nerezová ocel Brushed stainless steel Gebürstet Edelstahl Шлифованная нержавеющая сталь
304/EN 1.4301 |
| WH | Bílá White Weiss Белая 304/EN 1.4301 |
| GR | Šedá metalíza Grey metallic Grau metallic
Серый металл 304/EN 1.4301 |
| BL | Černá Black Schwarz Черная 304/EN 1.4301 |



Levé (L)/pravé (R) otevírání na objednávku
Opening direction left (L)/right (R) to select
Türöffnung links (L)/rechts (R) zu Bestellen
Левое (L)/правое (R) открывание на заказ

**P.PW2D
WC 800**



SB

**P.PW2D LWH
WC 800**



WH

**P.PW2D LGR
WC 800**



GR

**P.PW2D LBL
WC 800**



BL

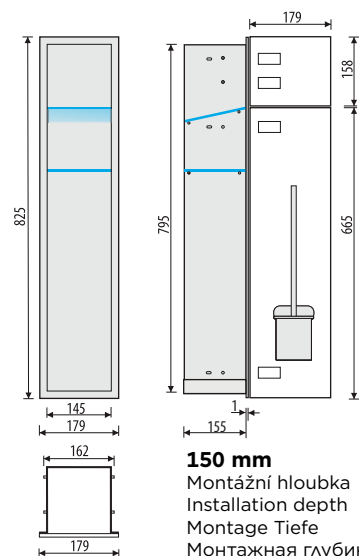

Verze Slim | Slim type | Slim version | Версия Slim

**P.PWAD
WC 450**



SB

**P.PWAD LWH
WC 450**



WH

**P.PWAD LGR
WC 450**



GR

**P.PWAD LBL
WC 450**



BL

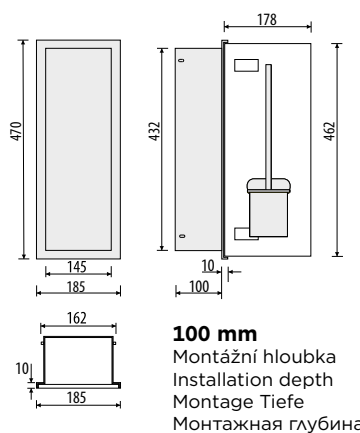



UNO

Vestavný wc box z nerezové oceli na štětku a toaletní papír s dvířky do obkladu

Built-in Stainless steel container for toilet with tileable doors

WC Edelstahl Wandeinbaumodule mit Bürstengarnitur und Papierrollenhalter mit befliesbaren Türen

Встраиваемый модуль для туалета с дверцей под плитку

Typ oceli:
Steel grade:
Stahlsorte:
Тип стали:

- SB** Kartáčovaná nerezová ocel | Brushed stainless steel | Gebürstet Edelstahl
Шлифованная нержавеющая сталь **304/EN 1.4301**
- WH** Bílá | White | Weiss | Белая **304/EN 1.4301**
- GR** Šedá metalíza | Grey metallic | Grau metallic
Серый металл **304/EN 1.4301**
- BL** Černá | Black | Schwarz | Черная **304/EN 1.4301**

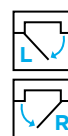

Levé (L)/pravé (R) otevírání na objednávku
Opening direction left (L)/right (R) to select
Türöffnung links (L)/rechts (R) zu Bestellen
Левое (L)/правое (R) открывание на заказ

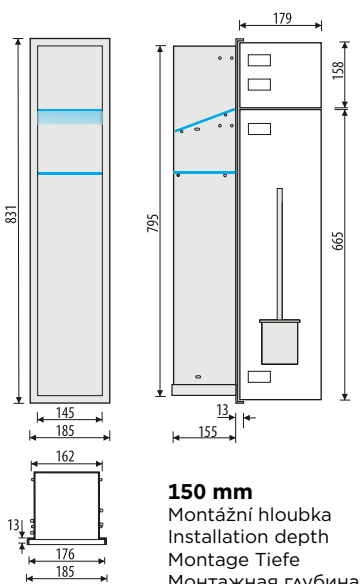

**U.PW2T
WC 800**



SB

**U.PW2T LWH
WC 800**



WH

**U.PW2T LGR
WC 800**



GR

**U.PW2T LBL
WC 800**



BL

Verze Slim | Slim type | Slim version | Версия Slim

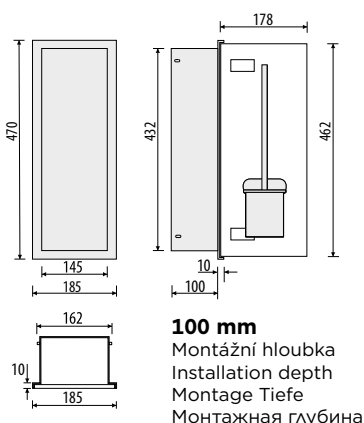

**U.PWAT
WC 450**



SB

**U.PWAT LWH
WC 450**



WH

**U.PWAT LGR
WC 450**



GR

**U.PWAT LBL
WC 450**



BL

Typy skla

Types of glass doors
Arten von Glastüren
Типы стекла

Mirror MR

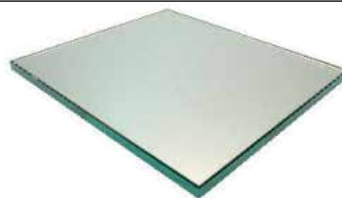

White glossy WH



Grey glossy GR



Black glossy BL

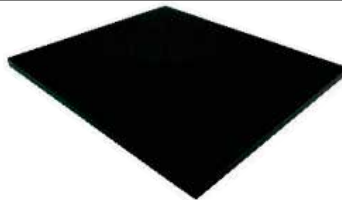

White satin ATWH



Latte satin STLT

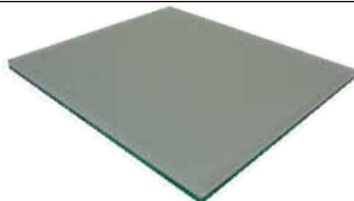

Black satin STBL

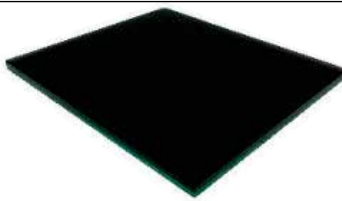

Montážní rám pro osazení boxu

Concealed mounting frame
Unterputz Einbaurahmen
Монтажная рама для установки встраиваемых модулей

BR 800 WC for/für/pro 800 PW2T/D

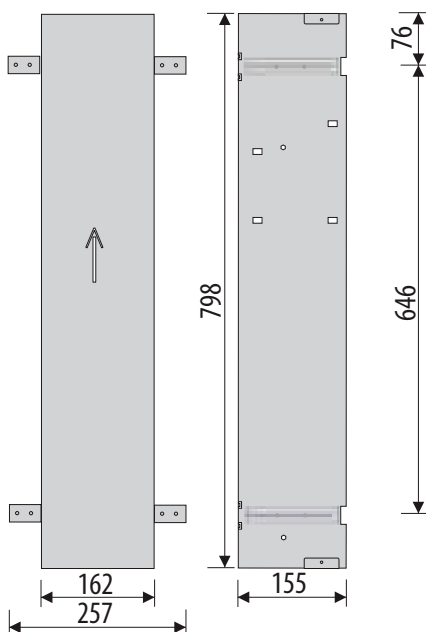

BR 450 WC for/für/pro 450 PWAD/T

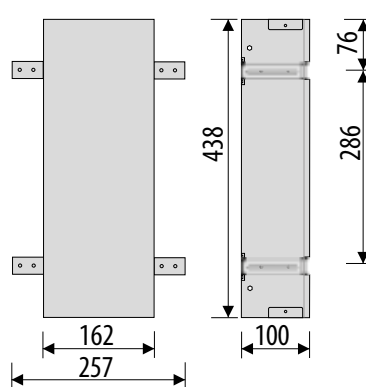

Typ skříně Modul type Modultyp Тип шкафа	Výška Height Höhe Высота	Barva konstrukce Box colour Modulfarbe Цвет модуля	Pravé/Levé Right/Left Rechts/Links Право/Лево	Typ skla Glass door type Art von Glastüren Тип стекла	Описание Complete description Ganze Beschreibung Celý popis	Objednávkový kód Order no. Bestellnummer Код заказа
PLATE						
P.PW2D	WC 800	SB	(DIN R)	MR	P.PW2D SB WC 800 (DIN R) MR	772201101
P.PW2D	WC 800	LWH	(DIN R)	MR	P.PW2D LWH WC 800 (DIN R) MR	772202101
P.PW2D	WC 800	LGR	(DIN R)	MR	P.PW2D LGR WC 800 (DIN R) MR	772203101
P.PW2D	WC 800	LBL	(DIN R)	MR	P.PW2D LBL WC 800 (DIN R) MR	772204101
P.PW2D	WC 800	SB	(DIN R)	WH	P.PW2D SB WC 800 (DIN R) WH	772201102
P.PW2D	WC 800	LWH	(DIN R)	WH	P.PW2D LWH WC 800 (DIN R) WH	772202102
P.PW2D	WC 800	LGR	(DIN R)	WH	P.PW2D LGR WC 800 (DIN R) WH	772203102
P.PW2D	WC 800	LBL	(DIN R)	WH	P.PW2D LBL WC 800 (DIN R) WH	772204102
P.PW2D	WC 800	SB	(DIN R)	GR	P.PW2D SB WC 800 (DIN R) GR	772201103
P.PW2D	WC 800	LWH	(DIN R)	GR	P.PW2D LWH WC 800 (DIN R) GR	772202103
P.PW2D	WC 800	LGR	(DIN R)	GR	P.PW2D LGR WC 800 (DIN R) GR	772203103
P.PW2D	WC 800	LBL	(DIN R)	GR	P.PW2D LBL WC 800 (DIN R) GR	772204103
P.PW2D	WC 800	SB	(DIN R)	BL	P.PW2D SB WC 800 (DIN R) BL	772201104
P.PW2D	WC 800	LWH	(DIN R)	BL	P.PW2D LWH WC 800 (DIN R) BL	772202104
P.PW2D	WC 800	LGR	(DIN R)	BL	P.PW2D LGR WC 800 (DIN R) BL	772203104
P.PW2D	WC 800	LBL	(DIN R)	BL	P.PW2D LBL WC 800 (DIN R) BL	772204104
P.PW2D	WC 800	SB	(DIN R)	STWH	P.PW2D SB WC 800 (DIN R) STWH	772201105
P.PW2D	WC 800	LWH	(DIN R)	STWH	P.PW2D LWH WC 800 (DIN R) STWH	772202105
P.PW2D	WC 800	LGR	(DIN R)	STWH	P.PW2D LGR WC 800 (DIN R) STWH	772203105
P.PW2D	WC 800	LBL	(DIN R)	STWH	P.PW2D LBL WC 800 (DIN R) STWH	772204105
P.PW2D	WC 800	SB	(DIN R)	STLT	P.PW2D SB WC 800 (DIN R) STLT	772201106
P.PW2D	WC 800	LWH	(DIN R)	STLT	P.PW2D LWH WC 800 (DIN R) STLT	772202106
P.PW2D	WC 800	LGR	(DIN R)	STLT	P.PW2D LGR WC 800 (DIN R) STLT	772203106
P.PW2D	WC 800	LBL	(DIN R)	STLT	P.PW2D LBL WC 800 (DIN R) STLT	772204106
P.PW2D	WC 800	SB	(DIN R)	STBL	P.PW2D SB WC 800 (DIN R) STBL	772201107
P.PW2D	WC 800	LWH	(DIN R)	STBL	P.PW2D LWH WC 800 (DIN R) STBL	772202107
P.PW2D	WC 800	LGR	(DIN R)	STBL	P.PW2D LGR WC 800 (DIN R) STBL	772203107
P.PW2D	WC 800	LBL	(DIN R)	STBL	P.PW2D LBL WC 800 (DIN R) STBL	772204107
P.PW2D	WC 800	SB	(DIN L)	MR	P.PW2D SB WC 800 (DIN L) MR	772201001
P.PW2D	WC 800	LWH	(DIN L)	MR	P.PW2D LWH WC 800 (DIN L) MR	772202001
P.PW2D	WC 800	LGR	(DIN L)	MR	P.PW2D LGR WC 800 (DIN L) MR	772203001
P.PW2D	WC 800	LBL	(DIN L)	MR	P.PW2D LBL WC 800 (DIN L) MR	772204001
P.PW2D	WC 800	SB	(DIN L)	WH	P.PW2D SB WC 800 (DIN L) WH	772201002
P.PW2D	WC 800	LWH	(DIN L)	WH	P.PW2D LWH WC 800 (DIN L) WH	772202002
P.PW2D	WC 800	LGR	(DIN L)	WH	P.PW2D LGR WC 800 (DIN L) WH	772203002
P.PW2D	WC 800	LBL	(DIN L)	WH	P.PW2D LBL WC 800 (DIN L) WH	772204002
P.PW2D	WC 800	SB	(DIN L)	GR	P.PW2D SB WC 800 (DIN L) GR	772201003
P.PW2D	WC 800	LWH	(DIN L)	GR	P.PW2D LWH WC 800 (DIN L) GR	772202003
P.PW2D	WC 800	LGR	(DIN L)	GR	P.PW2D LGR WC 800 (DIN L) GR	772203003
P.PW2D	WC 800	LBL	(DIN L)	GR	P.PW2D LBL WC 800 (DIN L) GR	772204003
P.PW2D	WC 800	SB	(DIN L)	BL	P.PW2D SB WC 800 (DIN L) BL	772201004
P.PW2D	WC 800	LWH	(DIN L)	BL	P.PW2D LWH WC 800 (DIN L) BL	772202004
P.PW2D	WC 800	LGR	(DIN L)	BL	P.PW2D LGR WC 800 (DIN L) BL	772203004
P.PW2D	WC 800	LBL	(DIN L)	BL	P.PW2D LBL WC 800 (DIN L) BL	772204004
P.PW2D	WC 800	SB	(DIN L)	STWH	P.PW2D SB WC 800 (DIN L) STWH	772201005
P.PW2D	WC 800	LWH	(DIN L)	STWH	P.PW2D LWH WC 800 (DIN L) STWH	772202005
P.PW2D	WC 800	LGR	(DIN L)	STWH	P.PW2D LGR WC 800 (DIN L) STWH	772203005
P.PW2D	WC 800	LBL	(DIN L)	STWH	P.PW2D LBL WC 800 (DIN L) STWH	772204005
P.PW2D	WC 800	SB	(DIN L)	STLT	P.PW2D SB WC 800 (DIN L) STLT	772201006
P.PW2D	WC 800	LWH	(DIN L)	STLT	P.PW2D LWH WC 800 (DIN L) STLT	772202006
P.PW2D	WC 800	LGR	(DIN L)	STLT	P.PW2D LGR WC 800 (DIN L) STLT	772203006
P.PW2D	WC 800	LBL	(DIN L)	STLT	P.PW2D LBL WC 800 (DIN L) STLT	772204006
P.PW2D	WC 800	SB	(DIN L)	STBL	P.PW2D SB WC 800 (DIN L) STBL	772201007
P.PW2D	WC 800	LWH	(DIN L)	STBL	P.PW2D LWH WC 800 (DIN L) STBL	772202007

Typ skříně Modul type Modultyp Тип шкафа	Výška Height Höhe Высота	Barva konstrukce Box colour Modulfarbe Цвет модуля	Pravé/Levé Right/Left Rechts/Links Право/Лево	Typ skla Glass door type Art von Glastüren Тип стекла	Описание Complete description Ganze Beschreibung Celý popis	Objednávkový kód Order no. Bestellnummer Код заказа
P.PW2D	WC 800	LGR	(DIN L)	STBL	P.PW2D LGR WC 800 (DIN L) STBL	772203007
P.PW2D	WC 800	LBL	(DIN L)	STBL	P.PW2D LBL WC 800 (DIN L) STBL	772204007
P.PWAD	WC 450	SB	(DIN R)	MR	P.PWAD SBWC 450 (DIN R) MR	774201101
P.PWAD	WC 450	LWH	(DIN R)	MR	P.PWAD LWHWC 450 (DIN R) MR	774202101
P.PWAD	WC 450	LGR	(DIN R)	MR	P.PWAD LGRWC 450 (DIN R) MR	774203101
P.PWAD	WC 450	LBL	(DIN R)	MR	P.PWAD LBLWC 450 (DIN R) MR	774204101
P.PWAD	WC 450	SB	(DIN R)	WH	P.PWAD SBWC 450 (DIN R) WH	774201102
P.PWAD	WC 450	LWH	(DIN R)	WH	P.PWAD LWHWC 450 (DIN R) WH	774202102
P.PWAD	WC 450	LGR	(DIN R)	WH	P.PWAD LGRWC 450 (DIN R) WH	774203102
P.PWAD	WC 450	LBL	(DIN R)	WH	P.PWAD LBLWC 450 (DIN R) WH	774204102
P.PWAD	WC 450	SB	(DIN R)	GR	P.PWAD SBWC 450 (DIN R) GR	774201103
P.PWAD	WC 450	LWH	(DIN R)	GR	P.PWAD LWHWC 450 (DIN R) GR	774202103
P.PWAD	WC 450	LGR	(DIN R)	GR	P.PWAD LGRWC 450 (DIN R) GR	774203103
P.PWAD	WC 450	LBL	(DIN R)	GR	P.PWAD LBLWC 450 (DIN R) GR	774204103
P.PWAD	WC 450	SB	(DIN R)	BL	P.PWAD SBWC 450 (DIN R) BL	774201104
P.PWAD	WC 450	LWH	(DIN R)	BL	P.PWAD LWHWC 450 (DIN R) BL	774202104
P.PWAD	WC 450	LGR	(DIN R)	BL	P.PWAD LGRWC 450 (DIN R) BL	774203104
P.PWAD	WC 450	LBL	(DIN R)	BL	P.PWAD LBLWC 450 (DIN R) BL	774204104
P.PWAD	WC 450	SB	(DIN R)	STWH	P.PWAD SBWC 450 (DIN R) STWH	774201105
P.PWAD	WC 450	LWH	(DIN R)	STWH	P.PWAD LWHWC 450 (DIN R) STWH	774202105
P.PWAD	WC 450	LGR	(DIN R)	STWH	P.PWAD LGRWC 450 (DIN R) STWH	774203105
P.PWAD	WC 450	LBL	(DIN R)	STWH	P.PWAD LBLWC 450 (DIN R) STWH	774204105
P.PWAD	WC 450	SB	(DIN R)	STLT	P.PWAD SBWC 450 (DIN R) STLT	774201106
P.PWAD	WC 450	LWH	(DIN R)	STLT	P.PWAD LWHWC 450 (DIN R) STLT	774202106
P.PWAD	WC 450	LGR	(DIN R)	STLT	P.PWAD LGRWC 450 (DIN R) STLT	774203106
P.PWAD	WC 450	LBL	(DIN R)	STLT	P.PWAD LBLWC 450 (DIN R) STLT	774204106
P.PWAD	WC 450	SB	(DIN R)	STBL	P.PWAD SBWC 450 (DIN R) STBL	774201107
P.PWAD	WC 450	LWH	(DIN R)	STBL	P.PWAD LWHWC 450 (DIN R) STBL	774202107
P.PWAD	WC 450	LGR	(DIN R)	STBL	P.PWAD LGRWC 450 (DIN R) STBL	774203107
P.PWAD	WC 450	LBL	(DIN R)	STBL	P.PWAD LBLWC 450 (DIN R) STBL	774204107
P.PWAD	WC 450	SB	(DIN L)	MR	P.PWAD SBWC 450 (DIN L) MR	774201001
P.PWAD	WC 450	LWH	(DIN L)	MR	P.PWAD LWHWC 450 (DIN L) MR	774202001
P.PWAD	WC 450	LGR	(DIN L)	MR	P.PWAD LGRWC 450 (DIN L) MR	774203001
P.PWAD	WC 450	LBL	(DIN L)	MR	P.PWAD LBLWC 450 (DIN L) MR	774204001
P.PWAD	WC 450	SB	(DIN L)	WH	P.PWAD SBWC 450 (DIN L) WH	774201002
P.PWAD	WC 450	LWH	(DIN L)	WH	P.PWAD LWHWC 450 (DIN L) WH	774202002
P.PWAD	WC 450	LGR	(DIN L)	WH	P.PWAD LGRWC 450 (DIN L) WH	774203002
P.PWAD	WC 450	LBL	(DIN L)	WH	P.PWAD LBLWC 450 (DIN L) WH	774204002
P.PWAD	WC 450	SB	(DIN L)	GR	P.PWAD SBWC 450 (DIN L) GR	774201003
P.PWAD	WC 450	LWH	(DIN L)	GR	P.PWAD LWHWC 450 (DIN L) GR	774202003
P.PWAD	WC 450	LGR	(DIN L)	GR	P.PWAD LGRWC 450 (DIN L) GR	774203003
P.PWAD	WC 450	LBL	(DIN L)	GR	P.PWAD LBLWC 450 (DIN L) GR	774204003
P.PWAD	WC 450	SB	(DIN L)	BL	P.PWAD SBWC 450 (DIN L) BL	774201004
P.PWAD	WC 450	LWH	(DIN L)	BL	P.PWAD LWHWC 450 (DIN L) BL	774202004
P.PWAD	WC 450	LGR	(DIN L)	BL	P.PWAD LGRWC 450 (DIN L) BL	774203004
P.PWAD	WC 450	LBL	(DIN L)	BL	P.PWAD LBLWC 450 (DIN L) BL	774204004
P.PWAD	WC 450	SB	(DIN L)	STWH	P.PWAD SBWC 450 (DIN L) STWH	774201005
P.PWAD	WC 450	LWH	(DIN L)	STWH	P.PWAD LWHWC 450 (DIN L) STWH	774202005
P.PWAD	WC 450	LGR	(DIN L)	STWH	P.PWAD LGRWC 450 (DIN L) STWH	774203005
P.PWAD	WC 450	LBL	(DIN L)	STWH	P.PWAD LBLWC 450 (DIN L) STWH	774204005
P.PWAD	WC 450	SB	(DIN L)	STLT	P.PWAD SBWC 450 (DIN L) STLT	774201006
P.PWAD	WC 450	LWH	(DIN L)	STLT	P.PWAD LWHWC 450 (DIN L) STLT	774202006
P.PWAD	WC 450	LGR	(DIN L)	STLT	P.PWAD LGRWC 450 (DIN L) STLT	774203006
P.PWAD	WC 450	LBL	(DIN L)	STLT	P.PWAD LBLWC 450 (DIN L) STLT	774204006
P.PWAD	WC 450	SB	(DIN L)	STBL	P.PWAD SBWC 450 (DIN L) STBL	774201007

Typ skříně Modul type Modultyp Тип шкафа	Výška Height Höhe Высота	Barva konstrukce Box colour Modulfarbe Цвет модуля	Pravé/Levé Right/Left Rechts/Links Право/Лево	Typ skla Glass door type Art von Glastüren Тип стекла	Описание Complete description Ganze Beschreibung Celý popis	Objednávkový kód Order no. Bestellnummer Код заказа
P.PWAD	WC 450	LWH	(DIN L)	STBL	P.PWAD LWHWC 450 (DIN L) STBL	774202007
P.PWAD	WC 450	LGR	(DIN L)	STBL	P.PWAD LGRWC 450 (DIN L) STBL	774203007
P.PWAD	WC 450	LBL	(DIN L)	STBL	P.PWAD LBLWC 450 (DIN L) STBL	774204007
UNO						
U.PW2T	WC 800	SB	(DIN R)		U.PW2T SB WC 800 (DIN R)	771201101
U.PW2T	WC 800	LWH	(DIN R)		U.PW2T LWH WC 800 (DIN R)	771202101
U.PW2T	WC 800	LGR	(DIN R)		U.PW2T LGR WC 800 (DIN R)	771203101
U.PW2T	WC 800	LBL	(DIN R)		U.PW2T LBL WC 800 (DIN R)	771204101
U.PW2T	WC 800	SB	(DIN L)		U.PW2T SB WC 800 (DIN L)	771201001
U.PW2T	WC 800	LWH	(DIN L)		U.PW2T LWH WC 800 (DIN L)	771202001
U.PW2T	WC 800	LGR	(DIN L)		U.PW2T LGR WC 800 (DIN L)	771203001
U.PW2T	WC 800	LBL	(DIN L)		U.PW2T LBL WC 800 (DIN L)	771204001
U.PWAT	WC 450	SB	(DIN R)		U.PWAT SB WC 450 (DIN R)	771301101
U.PWAT	WC 450	LWH	(DIN R)		U.PWAT LWH WC 450 (DIN R)	771302101
U.PWAT	WC 450	LGR	(DIN R)		U.PWAT LGR WC 450 (DIN R)	771303101
U.PWAT	WC 450	LBL	(DIN R)		U.PWAT LBL WC 450 (DIN R)	771304101
U.PWAT	WC 450	SB	(DIN L)		U.PWAT SB WC 450 (DIN L)	771301001
U.PWAT	WC 450	LWH	(DIN L)		U.PWAT LWH WC 450 (DIN L)	771302001
U.PWAT	WC 450	LGR	(DIN L)		U.PWAT LGR WC 450 (DIN L)	771303001
U.PWAT	WC 450	LBL	(DIN L)		U.PWAT LBL WC 450 (DIN L)	771304001
BR 450 WC						779490101
BR 800 WC						779290101



Poličky do koupelny z nerezové oceli

Bathroom shelves made of stainless steel

Badezimmerregale aus Edelstahl

Полочки для ванной из нержавеющей стали

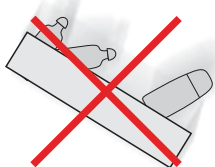
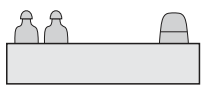

ANTI-DROP SYSTEM

Poličky do koupelny H-60mm

Bathroom shelves H-60mm

Badezimmerregale H-60mm

Полочки для ванной H-60мм

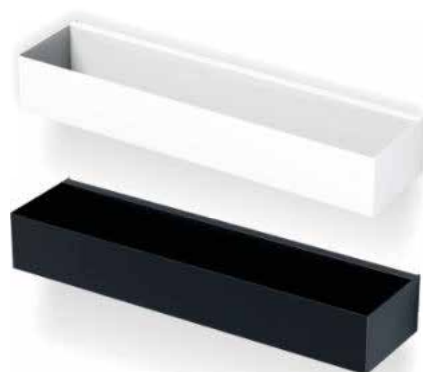

	H ↓	L ↔	B ↗
BS6030	60	300	100
BS6040	60	400	100
BS6050	60	500	100
BS6060	60	600	100



Volitelné barvy - práškové lakované
Possible colours of powder-coating
Mögliche Farben der Pulverbeschichtung
Дополнительные цвета - порошковое покрытие



Poličky do koupelny H-80mm

Bathroom shelves H-80mm

Badezimmerregale H-80mm

Полочки для ванной H-80мм



	H ↓	L ↔	B ↗
BS8030	80	300	100
BS8040	80	400	100
BS8050	80	500	100
BS8060	80	600	100

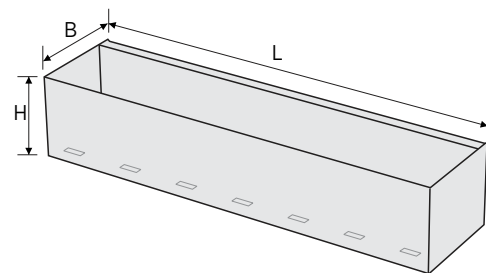

Volitelné barvy - práškové lakované
Possible colours of powder-coating
Mögliche Farben der Pulverbeschichtung
Дополнительные цвета - порошковое покрытие

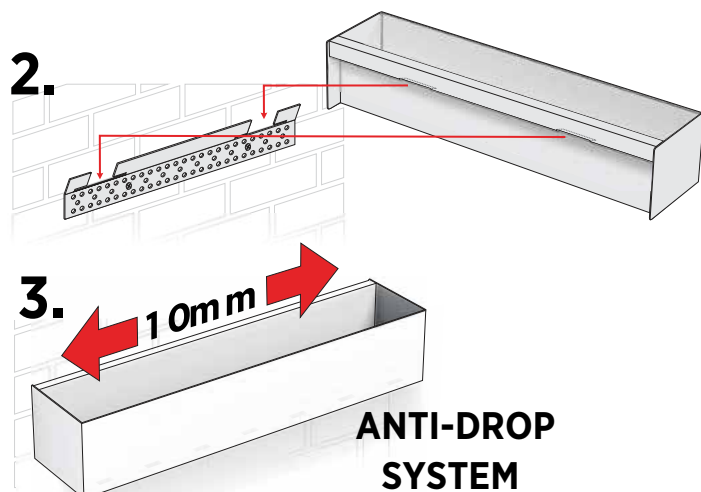
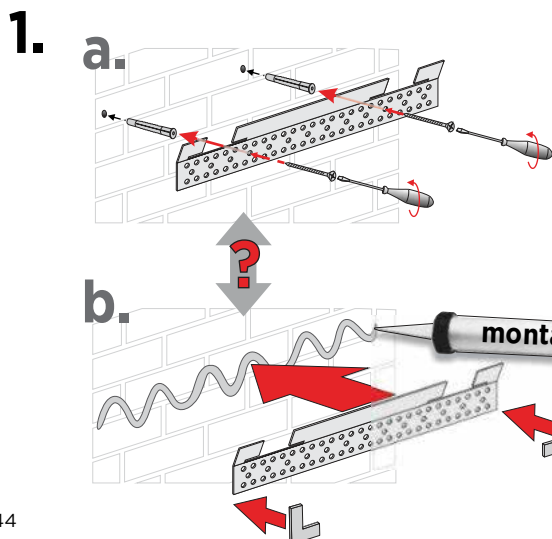

ANTI-DROP SYSTEM

Vestavné police z nerezové oceli do niky

Built-in st. steel containers

Edelstahl Wandeinbaunische

Встраиваемые в нишу полки из нержавеющей стали



Typ oceli | Steel grade | Stahlsorte | Тип стали:

SB **Kartáčovaná nerezová ocel** | Brushed stainless steel |
Gebürstet Edelstahl | Шлифованная нержавеющая сталь **304/EN 1.4301**

WH **Bílá** | White | Weiss | Белая **304/EN 1.4301**

GR **Šedá metalíza** | Grey metallic |
Grau metallic | Серый металл **304/EN 1.4301**

BL **Černá** | Black | Schwarz | Черная **304/EN 1.4301**

Vestavná polička z nerezů do niky

Built-in st. steel container
Edelstahl Wandeinbaunische
Встраиваемая в нишу полка из нержавеющей стали

P.PWN



SB

P.PWN LWH



WH

P.PWN LGR



GR

P.PWN LBL



BL

P.PWN 600/10
P.PWN 600/15*

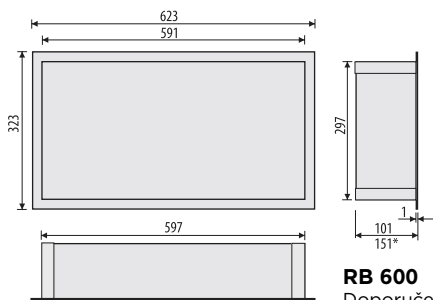

RB 600

Doporučený montážní rám
Suggested mounting frame
Empfohlener Einbaurahmen
Рекомендуемая монтажная рама

P.PWN 900/10
P.PWN 900/15*

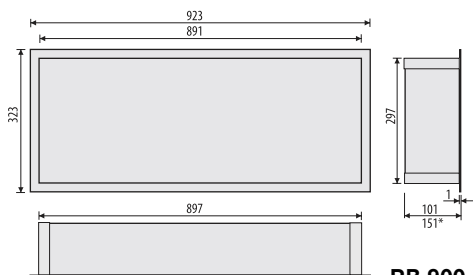

RB 900

Doporučený montážní rám
Suggested mounting frame
Empfohlener Einbaurahmen
Рекомендуемая монтажная рама



P.PWN 200/10
P.PWN 200/15*

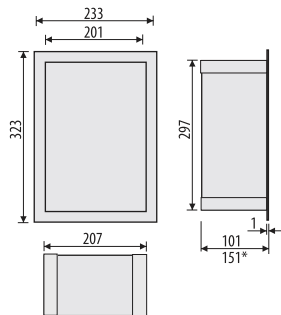

P.PWN 300/10
P.PWN 300/15*

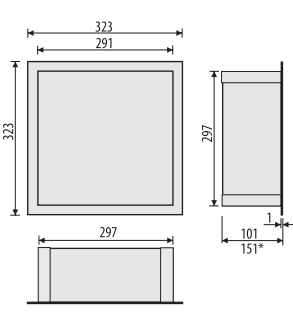

RB 200

Doporučený montážní rám
Suggested mounting frame
Empfohlener Einbaurahmen
Рекомендуемая монтажная рама

RB 300

Doporučený montážní rám
Suggested mounting frame
Empfohlener Einbaurahmen
Рекомендуемая монтажная рама

Modul Module Modul Модуль	Hĺoubka cm Depth cm Tiefe cm Глубина см	Typ oceli Steel grade Stahlsorte Тип стали	Kód Code Code Код
P.PWN 200	10	SB	781101001
P.PWN 200	10	LWH	781101002
P.PWN 200	10	LBL	781101003
P.PWN 200	10	LGR	781101004
P.PWN 300	10	SB	781101005
P.PWN 300	10	LWH	781101006
P.PWN 300	10	LBL	781101007
P.PWN 300	10	LGR	781101008
P.PWN 600	10	SB	781101009
P.PWN 600	10	LWH	781101010
P.PWN 600	10	LBL	781101011
P.PWN 600	10	LGR	781101012
P.PWN 900	10	SB	781101013
P.PWN 900	10	LWH	781101014
P.PWN 900	10	LBL	781101015
P.PWN 900	10	LGR	781101016
P.PWN 200	15	SB	781101017
P.PWN 200	15	LWH	781101018
P.PWN 200	15	LBL	781101019
P.PWN 200	15	LGR	781101020
P.PWN 300	15	SB	781101021
P.PWN 300	15	LWH	781101022
P.PWN 300	15	LBL	781101023
P.PWN 300	15	LGR	781101024
P.PWN 600	15	SB	781101025
P.PWN 600	15	LWH	781101026
P.PWN 600	15	LBL	781101027
P.PWN 600	15	LGR	781101028
P.PWN 900	15	SB	781101029
P.PWN 900	15	LWH	781101030
P.PWN 900	15	LBL	781101031
P.PWN 900	15	LGR	781101032

Vestavná polička s LED osvětlením z nerezi do niky

Built-in st. steel container with LED lighting
Edelstahl Wandeinbaunisiche mit LED Beleuchtung
Встраиваемая в нишу полка из нерж. стали с подсветкой

X IP65 na objednávku
IP65 on request
IP65 nach Anfrage
IP65 на заказ

P.PWN LED



SB

P.PWH LWH LED



WH

P.PWN LGR LED



GR

P.PWN LBL LED



BL

P.PWN LED 200/10
P.PWN LED 200/15*

IP20 NW -4000K W ~1,92

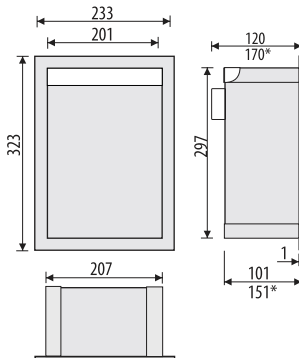

Pro | For | Für | Для
IP65 RBD 200/15 *17,5

RB 200
Doporučený montážní rám
Suggested mounting frame
Empfohlener Einbaurahmen
Рекомендуемая монтажная рама

P.PWN LED 300/10
P.PWN LED 300/15*

IP20 NW -4000K W ~2,64

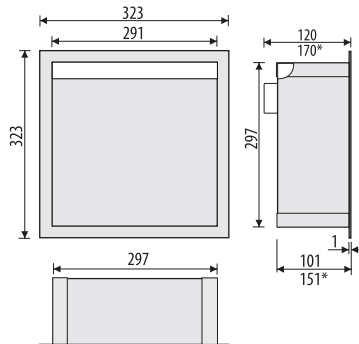

For | Für | Pro
IP65 RBD 300/15 *17,5

RB 300
Doporučený montážní rám
Suggested mounting frame
Empfohlener Einbaurahmen
Рекомендуемая монтажная рама

P.PWN LED 600/10
P.PWN LED 600/15*

IP20 NW -4000K W ~5,52

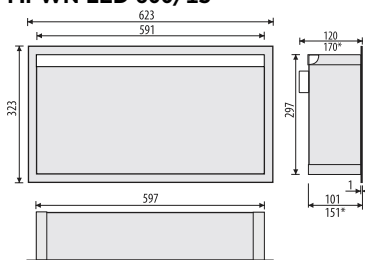

Pro | For | Für | Для
IP65 RBD 600/15 *17,5

RB 600
Doporučený montážní rám
Suggested mounting frame
Empfohlener Einbaurahmen
Рекомендуемая монтажная рама

P.PWN LED 900/10
P.PWN LED 900/15*

IP20 NW -4000K W ~8,4

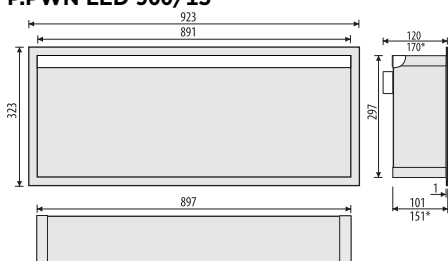

For | Für | Pro
IP65 RBD 900/15 *17,5

RB 900
Doporučený montážní rám
Suggested mounting frame
Empfohlener Einbaurahmen
Рекомендуемая монтажная рама

Modul Module Modul Модуль	Hĺoubka cm Depth cm Tiefe cm Глубина см	Typ oceli Steel grade Stahlsorte Тип стали	Kód Code Code Код
P.PWN 200 LED	10	SB	781201001
P.PWN 200 LED	10	LWH	781201002
P.PWN 200 LED	10	LBL	781201003
P.PWN 200 LED	10	LGR	781201004
P.PWN 300 LED	10	SB	781201005
P.PWN 300 LED	10	LWH	781201006
P.PWN 300 LED	10	LBL	781201007
P.PWN 300 LED	10	LGR	781201008
P.PWN 600 LED	10	SB	781201009
P.PWN 600 LED	10	LWH	781201010
P.PWN 600 LED	10	LBL	781201011
P.PWN 600 LED	10	LGR	781201012
P.PWN 900 LED	10	SB	781201013
P.PWN 900 LED	10	LWH	781201014
P.PWN 900 LED	10	LBL	781201015
P.PWN 900 LED	10	LGR	781201016
P.PWN 200 LED	15	SB	781201017
P.PWN 200 LED	15	LWH	781201018
P.PWN 200 LED	15	LBL	781201019
P.PWN 200 LED	15	LGR	781201020
P.PWN 300 LED	15	SB	781201021
P.PWN 300 LED	15	LWH	781201022
P.PWN 300 LED	15	LBL	781201023
P.PWN 300 LED	15	LGR	781201024
P.PWN 600 LED	15	SB	781201025
P.PWN 600 LED	15	LWH	781201026
P.PWN 600 LED	15	LBL	781201027
P.PWN 600 LED	15	LGR	781201028
P.PWN 900 LED	15	SB	781201029
P.PWN 900 LED	15	LWH	781201030
P.PWN 900 LED	15	LBL	781201031
P.PWN 900 LED	15	LGR	781201032

Vestavná police z nerezí se skleněnými poličkami

Built-in st. steel container with glass shelves

Edelstahl Wandeinbaunische mit Glasablagen

Встраиваемая в нишу полка из нержавеющей стали со стеклянными полочками



P.PWNP



SB

P.PWNP LWH



WH

P.PWN LGR



GR

P.PWNP LGR



BL

**P.PWNP 3060/10
P.PWNP 3060/15***

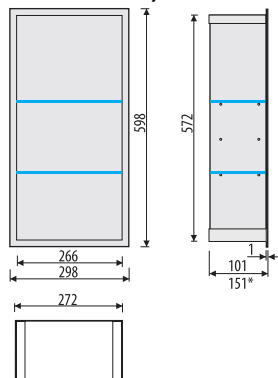

**P.PWNP 3080/10
P.PWNP 3080/15***

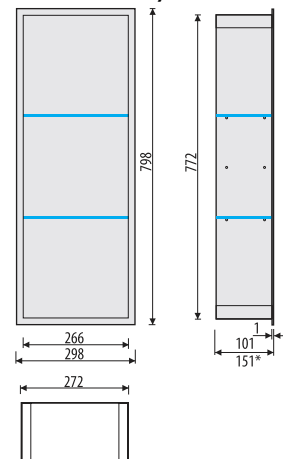

RB ES 3060

Doporučený montážní rám
Suggested mounting frame
Empfohlener Einbaurahmen
Рекомендуемая монтажная рама

RB ES 3080

Doporučený montážní rám
Suggested mounting frame
Empfohlener Einbaurahmen
Рекомендуемая монтажная рама

**P.PWNP 600/10
P.PWNP 600/15***

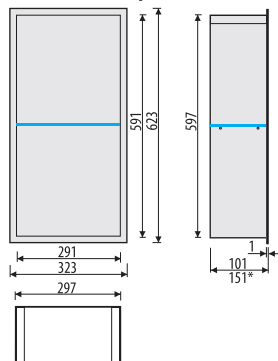

**P.PWNP 900/10
P.PWNP 900/15***

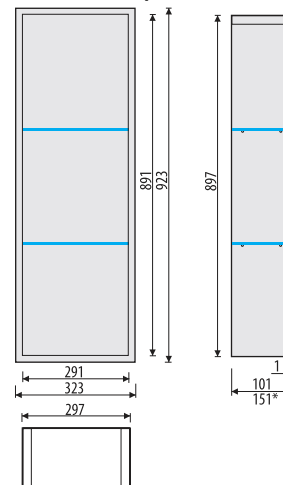

RB 600

Doporučený montážní rám
Suggested mounting frame
Empfohlener Einbaurahmen
Рекомендуемая монтажная рама

RB 900

Doporučený montážní rám
Suggested mounting frame
Empfohlener Einbaurahmen
Рекомендуемая монтажная рама

Modul Module Modul Модуль	Hĺoubka cm Depth cm Tiefe cm Глубина cm	Typ oceli Steel grade Stahlsorte Тип стали	Kód Code Code Код
P.PWNP 3060	10	SB	781301001
P.PWNP 3060	10	LWH	781301002
P.PWNP 3060	10	LBL	781301003
P.PWNP 3060	10	LGR	781301004
P.PWNP 3080	10	SB	781301005
P.PWNP 3080	10	LWH	781301006
P.PWNP 3080	10	LBL	781301007
P.PWNP 3080	10	LGR	781301008
P.PWNP 600	10	SB	781301009
P.PWNP 600	10	LWH	781301010
P.PWNP 600	10	LBL	781301011
P.PWNP 600	10	LGR	781301012
P.PWNP 900	10	SB	781301013
P.PWNP 900	10	LWH	781301014
P.PWNP 900	10	LBL	781301015
P.PWNP 900	10	LGR	781301016

Vestavná police z nerezí s LED osvětlením se skleněnými poličkami

Built-in st. steel container with LED lightinh and glass shelves

Edelstahl Wandeinbaunische mit LED Beleuchtung und Glasablagen

Встраиваемая в нишу полка из нержавеющей стали со стеклянными полочками и светодиодной подсветкой

P.PWNP LED



SB

P.PWNP LWH LED



WH

P.PWNP LGR LED



GR

P.PWNP LBL LED



BL

P.PWNP LED 3060/10
P.PWNP LED 3060/15*

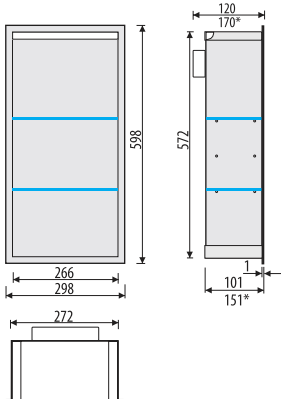

P.PWNP LED 600/10
P.PWNP LED 600/15*

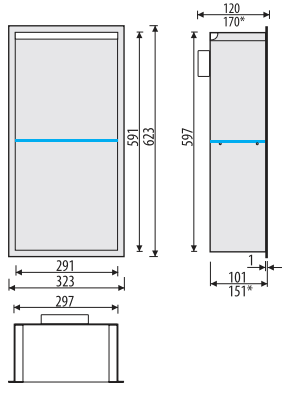

P.PWNP LED 3080/10
P.PWNP LED 3080/15*

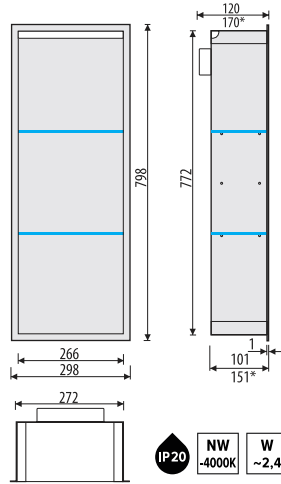

P.PWNP LED 900/10
P.PWNP LED 900/15*

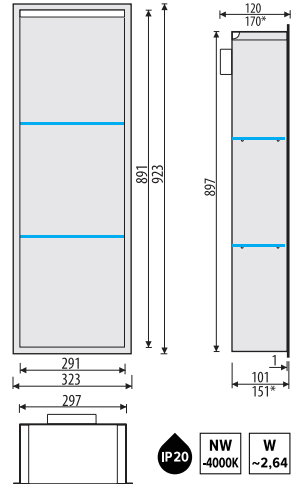

RB ES 3060

Doporučený montážní rám
Suggested mounting frame
Empfohlener Einbaurahmen
Рекомендуемая монтажная рама

RB 600

Doporučený montážní rám
Suggested mounting frame
Empfohlener Einbaurahmen
Рекомендуемая монтажная рама

RB ES 3080

Doporučený montážní rám
Suggested mounting frame
Empfohlener Einbaurahmen
Рекомендуемая монтажная рама

RB 900

Doporučený montážní rám
Suggested mounting frame
Empfohlener Einbaurahmen
Рекомендуемая монтажная рама

Modul Module Modul Модуль	Hĺouбка cm Depth cm Tiefe cm Глубина см	Typ oceli Steel grade Stahlsorte Тип стали	Kód Code Code Код	Modul Module Modul Модуль	Hĺouбка cm Depth cm Tiefe cm Глубина см	Typ oceli Steel grade Stahlsorte Тип стали	Kód Code Code Код	Modul Module Modul Модуль	Hĺouбка cm Depth cm Tiefe cm Глубина см	Typ oceli Steel grade Stahlsorte Тип стали	Kód Code Code Код
P.PWNP 3060	15	SB	781301017	P.PWNP 3080	15	LBL	781301023	P.PWNP 900	15	SB	781301029
P.PWNP 3060	15	LWH	781301018	P.PWNP 3080	15	LGR	781301024	P.PWNP 900	15	LWH	781301030
P.PWNP 3060	15	LBL	781301019	P.PWNP 600	15	SB	781301025	P.PWNP 900	15	LBL	781301031
P.PWNP 3060	15	LGR	781301020	P.PWNP 600	15	LWH	781301026	P.PWNP 900	15	LGR	781301032
P.PWNP 3080	15	SB	781301021	P.PWNP 600	15	LBL	781301027				
P.PWNP 3080	15	LWH	781301022	P.PWNP 600	15	LGR	781301028				

Vestavné police z nerezí se skleněnými poličkami a dvířky

Built-in st. steel container with glass shelves and doors
 Edelstahl Wandeinbaunische mit Glasablagen und Glastür
 Встраиваемая в нишу полка из нержавеющей стали со стеклянными полочками и дверцей

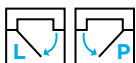

Levé/pravé otevírání na objednávku | Opening direction to select |
 Türöffnung zu Bestellen | Открывание влево/вправо по заказу

P.PWD



SB

P.PWD LWH



WH

P.PWD LGR



GR

P.PWD LBL



BL

P.PWD 3060/10
P.PWD 3060/15*

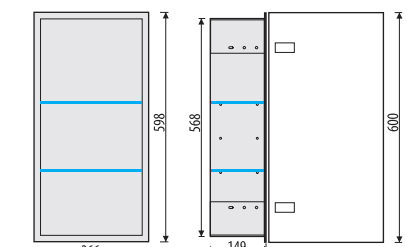

RB ES 3060

Doporučený montážní rám
 Suggested mounting frame
 Empfohlener Einbaurahmen
 Рекомендуемая монтажная рама

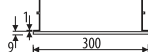

P.PWD 3080/10
P.PWD 3080/15*

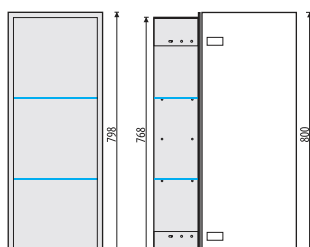

RB ES 3080

Doporučený montážní rám
 Suggested mounting frame
 Empfohlener Einbaurahmen
 Рекомендуемая монтажная рама

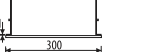

P.PWD 300/10
P.PWD 300/15*

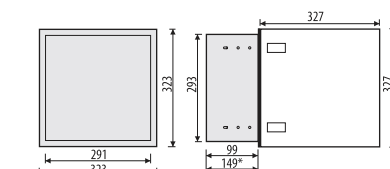

RB 300

Doporučený montážní rám
 Suggested mounting frame
 Empfohlener Einbaurahmen
 Рекомендуемая монтажная рама



P.PWD 600/10
P.PWD 600/15*

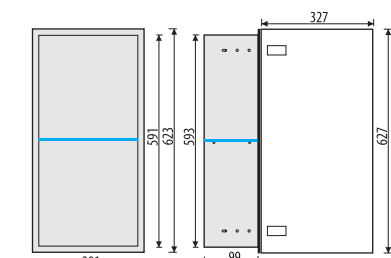

RB 600

Doporučený montážní rám
 Suggested mounting frame
 Empfohlener Einbaurahmen
 Рекомендуемая монтажная рама

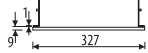

P.PWD 900/10
P.PWD 900/15*

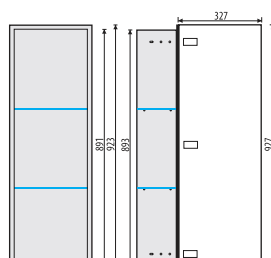

RB 900

Doporučený montážní rám
 Suggested mounting frame
 Empfohlener Einbaurahmen
 Рекомендуемая монтажная рама

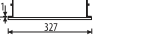

P.PWD 3060/10 cm

Typ oceli Steel grade Stahlsorte Тип стали	Otevirání Opening Türöffnung Открытие	Sklo Glass Glas Стекло	Kód Code Code Код
SB	DIN L	MR	781501001
SB	DIN L	WH	781501002
SB	DIN L	BL	781501003
SB	DIN L	GR	781501004
SB	DIN L	STWH	781501005
SB	DIN L	STBL	781501006
SB	DIN L	STLT	781501007
SB	DIN R	MR	781501008
SB	DIN R	WH	781501009
SB	DIN R	BL	781501010
SB	DIN R	GR	781501011
SB	DIN R	STWH	781501012
SB	DIN R	STBL	781501013
SB	DIN R	STLT	781501014
WH	DIN L	MR	781501015
WH	DIN L	WH	781501016
WH	DIN L	BL	781501017
WH	DIN L	GR	781501018
WH	DIN L	STWH	781501019
WH	DIN L	STBL	781501020
WH	DIN L	STLT	781501021
WH	DIN R	MR	781501022
WH	DIN R	WH	781501023
WH	DIN R	BL	781501024
WH	DIN R	GR	781501025
WH	DIN R	STWH	781501026
WH	DIN R	STBL	781501027
WH	DIN R	STLT	781501028
BL	DIN L	MR	781501029
BL	DIN L	WH	781501030
BL	DIN L	BL	781501031
BL	DIN L	GR	781501032
BL	DIN L	STWH	781501033
BL	DIN L	STBL	781501034
BL	DIN L	STLT	781501035
BL	DIN R	MR	781501036
BL	DIN R	WH	781501037
BL	DIN R	BL	781501038
BL	DIN R	GR	781501039
BL	DIN R	STWH	781501040
BL	DIN R	STBL	781501041
BL	DIN R	STLT	781501042
GR	DIN L	MR	781501043
GR	DIN L	WH	781501044
GR	DIN L	BL	781501045
GR	DIN L	GR	781501046
GR	DIN L	STWH	781501047
GR	DIN L	STBL	781501048
GR	DIN L	STLT	781501049
GR	DIN R	MR	781501050
GR	DIN R	WH	781501051
GR	DIN R	BL	781501052
GR	DIN R	GR	781501053
GR	DIN R	STWH	781501054
GR	DIN R	STBL	781501055
GR	DIN R	STLT	781501056

P.PWD 3060/15 cm

Typ oceli Steel grade Stahlsorte Тип стали	Otevirání Opening Türöffnung Открытие	Sklo Glass Glas Стекло	Kód Code Code Код
SB	DIN L	MR	781502001
SB	DIN L	WH	781502002
SB	DIN L	BL	781502003
SB	DIN L	GR	781502004
SB	DIN L	STWH	781502005
SB	DIN L	STBL	781502006
SB	DIN L	STLT	781502007
SB	DIN R	MR	781502008
SB	DIN R	WH	781502009

P.PWD 3060/15 cm

Typ oceli Steel grade Stahlsorte Тип стали	Otevirání Opening Türöffnung Открытие	Sklo Glass Glas Стекло	Kód Code Code Код
SB	DIN R	BL	781502010
SB	DIN R	GR	781502011
SB	DIN R	STWH	781502012
SB	DIN R	STBL	781502013
SB	DIN R	STLT	781502014
WH	DIN L	MR	781502015
WH	DIN L	WH	781502016
WH	DIN L	BL	781502017
WH	DIN L	GR	781502018
WH	DIN L	STWH	781502019
WH	DIN L	STBL	781502020
WH	DIN L	STLT	781502021
WH	DIN R	MR	781502022
WH	DIN R	WH	781502023
WH	DIN R	BL	781502024
WH	DIN R	GR	781502025
WH	DIN R	STWH	781502026
WH	DIN R	STBL	781502027
WH	DIN R	STLT	781502028
BL	DIN L	MR	781502029
BL	DIN L	WH	781502030
BL	DIN L	BL	781502031
BL	DIN L	GR	781502032
BL	DIN L	STWH	781502033
BL	DIN L	STBL	781502034
BL	DIN L	STLT	781502035
BL	DIN R	MR	781502036
BL	DIN R	WH	781502037
BL	DIN R	BL	781502038
BL	DIN R	GR	781502039
BL	DIN R	STWH	781502040
BL	DIN R	STBL	781502041
BL	DIN R	STLT	781502042
GR	DIN L	MR	781502043
GR	DIN L	WH	781502044
GR	DIN L	BL	781502045
GR	DIN L	GR	781502046
GR	DIN L	STWH	781502047
GR	DIN L	STBL	781502048
GR	DIN L	STLT	781502049
GR	DIN R	MR	781502050
GR	DIN R	WH	781502051
GR	DIN R	BL	781502052
GR	DIN R	GR	781502053
GR	DIN R	STWH	781502054
GR	DIN R	STBL	781502055
GR	DIN R	STLT	781502056

P.PWD 3080/10 cm

Typ oceli Steel grade Stahlsorte Тип стали	Otevirání Opening Türöffnung Открытие	Sklo Glass Glas Стекло	Kód Code Code Код
SB	DIN L	MR	781601001
SB	DIN L	WH	781601002
SB	DIN L	BL	781601003
SB	DIN L	GR	781601004
SB	DIN L	STWH	781601005
SB	DIN L	STBL	781601006
SB	DIN L	STLT	781601007
SB	DIN R	MR	781601008
SB	DIN R	WH	781601009
SB	DIN R	BL	781601010
SB	DIN R	GR	781601011
SB	DIN R	STWH	781601012
SB	DIN R	STBL	781601013
SB	DIN R	STLT	781601014
WH	DIN L	MR	781601015
WH	DIN L	WH	781601016
WH	DIN L	BL	781601017
WH	DIN L	GR	781601018
WH	DIN L	STWH	781601019

P.PWD 3080/10 cm

Typ oceli Steel grade Stahlsorte Тип стали	Otevirání Opening Türöffnung Открытие	Sklo Glass Glas Стекло	Kód Code Code Код
WH	DIN L	STBL	781601020
WH	DIN L	STLT	781601021
WH	DIN R	MR	781601022
WH	DIN R	WH	781601023
WH	DIN R	BL	781601024
WH	DIN R	GR	781601025
WH	DIN R	STWH	781601026
WH	DIN R	STBL	781601027
WH	DIN R	STLT	781601028
BL	DIN L	MR	781601029
BL	DIN L	WH	781601030
BL	DIN L	BL	781601031
BL	DIN L	GR	781601032
BL	DIN L	STWH	781601033
BL	DIN L	STBL	781601034
BL	DIN L	STLT	781601035
BL	DIN R	MR	781601036
BL	DIN R	WH	781601037
BL	DIN R	BL	781601038
BL	DIN R	GR	781601039
BL	DIN R	STWH	781601040
BL	DIN R	STBL	781601041
BL	DIN R	STLT	781601042
GR	DIN L	MR	781601043
GR	DIN L	WH	781601044
GR	DIN L	BL	781601045
GR	DIN L	GR	781601046
GR	DIN L	STWH	781601047
GR	DIN L	STBL	781601048
GR	DIN L	STLT	781601049
GR	DIN R	MR	781601050
GR	DIN R	WH	781601051
GR	DIN R	BL	781601052
GR	DIN R	GR	781601053
GR	DIN R	STWH	781601054
GR	DIN R	STBL	781601055
GR	DIN R	STLT	781601056

P.PWD 3060/10 cm

Typ oceli Steel grade Stahlsorte Тип стали	Otevirání Opening Türöffnung Открытие	Sklo Glass Glas Стекло	Kód Code Code Код
SB	DIN L	MR	781602001
SB	DIN L	WH	781602002
SB	DIN L	BL	781602003
SB	DIN L	GR	781602004
SB	DIN L	STWH	781602005
SB	DIN L	STBL	781602006
SB	DIN L	STLT	781602007
SB	DIN R	MR	781602008
SB	DIN R	WH	781602009
SB	DIN R	BL	781602010
SB	DIN R	GR	781602011
SB	DIN R	STWH	781602012
SB	DIN R	STBL	781602013
SB	DIN R	STLT	781602014
WH	DIN L	MR	781602015
WH	DIN L	WH	781602016
WH	DIN L	BL	781602017
WH	DIN L	GR	781602018
WH	DIN L	STWH	781602019
WH	DIN L	STBL	781602020
WH	DIN L	STLT	781602021
WH	DIN R	MR	781602022
WH	DIN R	WH	781602023
WH	DIN R	BL	781602024
WH	DIN R	GR	781602025
WH	DIN R	STWH	781602026
WH	DIN R	STBL	781602027
WH	DIN R	STLT	781602028
BL	DIN L	MR	781602029
BL	DIN L	WH	781602030

P.PWD 3060/10 cm

Typ oceli Steel grade Stahlsorte Тип стали	Otevirání Opening Türöffnung Открывание	Sklo Glass Glas Стекло	Kód Code Code Код
BL	DIN L	BL	781602031
BL	DIN L	GR	781602032
BL	DIN L	STWH	781602033
BL	DIN L	STBL	781602034
BL	DIN L	STLT	781602035
BL	DIN R	MR	781602036
BL	DIN R	WH	781602037
BL	DIN R	BL	781602038
BL	DIN R	GR	781602039
BL	DIN R	STWH	781602040
BL	DIN R	STBL	781602041
BL	DIN R	STLT	781602042
GR	DIN L	MR	781602043
GR	DIN L	WH	781602044
GR	DIN L	BL	781602045
GR	DIN L	GR	781602046
GR	DIN L	STWH	781602047
GR	DIN L	STBL	781602048
GR	DIN L	STLT	781602049
GR	DIN R	MR	781602050
GR	DIN R	WH	781602051
GR	DIN R	BL	781602052
GR	DIN R	GR	781602053
GR	DIN R	STWH	781602054
GR	DIN R	STBL	781602055
GR	DIN R	STLT	781602056

P.PWD 300/10 cm

Typ oceli Steel grade Stahlsorte Тип стали	Otevirání Opening Türöffnung Открывание	Sklo Glass Glas Стекло	Kód Code Code Код
SB	DIN L	MR	781701001
SB	DIN L	WH	781701002
SB	DIN L	BL	781701003
SB	DIN L	GR	781701004
SB	DIN L	STWH	781701005
SB	DIN L	STBL	781701006
SB	DIN L	STLT	781701007
SB	DIN R	MR	781701008
SB	DIN R	WH	781701009
SB	DIN R	BL	781701010
SB	DIN R	GR	781701011
SB	DIN R	STWH	781701012
SB	DIN R	STBL	781701013
SB	DIN R	STLT	781701014
WH	DIN L	MR	781701015
WH	DIN L	WH	781701016
WH	DIN L	BL	781701017
WH	DIN L	GR	781701018
WH	DIN L	STWH	781701019
WH	DIN L	STBL	781701020
WH	DIN L	STLT	781701021
WH	DIN R	MR	781701022
WH	DIN R	WH	781701023
WH	DIN R	BL	781701024
WH	DIN R	GR	781701025
WH	DIN R	STWH	781701026
WH	DIN R	STBL	781701027
WH	DIN R	STLT	781701028
BL	DIN L	MR	781701029
BL	DIN L	WH	781701030
BL	DIN L	BL	781701031
BL	DIN L	GR	781701032
BL	DIN L	STWH	781701033
BL	DIN L	STBL	781701034
BL	DIN L	STLT	781701035
BL	DIN R	MR	781701036
BL	DIN R	WH	781701037
BL	DIN R	BL	781701038
BL	DIN R	GR	781701039

P.PWD 300/10 cm

Typ oceli Steel grade Stahlsorte Тип стали	Otevirání Opening Türöffnung Открывание	Sklo Glass Glas Стекло	Kód Code Code Код
BL	DIN R	STWH	781701040
BL	DIN R	STBL	781701041
BL	DIN R	STLT	781701042
GR	DIN L	MR	781701043
GR	DIN L	WH	781701044
GR	DIN L	BL	781701045
GR	DIN L	GR	781701046
GR	DIN L	STWH	781701047
GR	DIN L	STBL	781701048
GR	DIN L	STLT	781701049
GR	DIN R	MR	781701050
GR	DIN R	WH	781701051
GR	DIN R	BL	781701052
GR	DIN R	GR	781701053
GR	DIN R	STWH	781701054
GR	DIN R	STBL	781701055
GR	DIN R	STLT	781701056

P.PWD 300/15 cm

Typ oceli Steel grade Stahlsorte Тип стали	Otevirání Opening Türöffnung Открывание	Sklo Glass Glas Стекло	Kód Code Code Код
SB	DIN L	MR	781702001
SB	DIN L	WH	781702002
SB	DIN L	BL	781702003
SB	DIN L	GR	781702004
SB	DIN L	STWH	781702005
SB	DIN L	STBL	781702006
SB	DIN L	STLT	781702007
SB	DIN R	MR	781702008
SB	DIN R	WH	781702009
SB	DIN R	BL	781702010
SB	DIN R	GR	781702011
SB	DIN R	STWH	781702012
SB	DIN R	STBL	781702013
SB	DIN R	STLT	781702014
WH	DIN L	MR	781702015
WH	DIN L	WH	781702016
WH	DIN L	BL	781702017
WH	DIN L	GR	781702018
WH	DIN L	STWH	781702019
WH	DIN L	STBL	781702020
WH	DIN L	STLT	781702021
WH	DIN R	MR	781702022
WH	DIN R	WH	781702023
WH	DIN R	BL	781702024
WH	DIN R	GR	781702025
WH	DIN R	STWH	781702026
WH	DIN R	STBL	781702027
WH	DIN R	STLT	781702028
BL	DIN L	MR	781702029
BL	DIN L	WH	781702030
BL	DIN L	BL	781702031
BL	DIN L	GR	781702032
BL	DIN L	STWH	781702033
BL	DIN L	STBL	781702034
BL	DIN L	STLT	781702035
BL	DIN R	MR	781702036
BL	DIN R	WH	781702037
BL	DIN R	BL	781702038
BL	DIN R	GR	781702039
BL	DIN R	STWH	781702040
BL	DIN R	STBL	781702041
BL	DIN R	STLT	781702042
GR	DIN L	MR	781702043
GR	DIN L	WH	781702044
GR	DIN L	BL	781702045
GR	DIN L	GR	781702046
GR	DIN L	STWH	781702047
GR	DIN L	STBL	781702048
GR	DIN L	STLT	781702049
GR	DIN R	MR	781702050

P.PWD 300/15 cm

Typ oceli Steel grade Stahlsorte Тип стали	Otevirání Opening Türöffnung Открывание	Sklo Glass Glas Стекло	Kód Code Code Код
GR	DIN R	WH	781702051
GR	DIN R	BL	781702052
GR	DIN R	GR	781702053
GR	DIN R	STWH	781702054
GR	DIN R	STBL	781702055
GR	DIN R	STLT	781702056

P.PWD 600/10 cm

Typ oceli Steel grade Stahlsorte Тип стали	Otevirání Opening Türöffnung Открывание	Sklo Glass Glas Стекло	Kód Code Code Код
SB	DIN L	MR	781801001
SB	DIN L	WH	781801002
SB	DIN L	BL	781801003
SB	DIN L	GR	781801004
SB	DIN L	STWH	781801005
SB	DIN L	STBL	781801006
SB	DIN L	STLT	781801007
SB	DIN R	MR	781801008
SB	DIN R	WH	781801009
SB	DIN R	BL	781801010
SB	DIN R	GR	781801011
SB	DIN R	STWH	781801012
SB	DIN R	STBL	781801013
SB	DIN R	STLT	781801014
WH	DIN L	MR	781801015
WH	DIN L	WH	781801016
WH	DIN L	BL	781801017
WH	DIN L	GR	781801018
WH	DIN L	STWH	781801019
WH	DIN L	STBL	781801020
WH	DIN L	STLT	781801021
WH	DIN R	MR	781801022
WH	DIN R	WH	781801023
WH	DIN R	BL	781801024
WH	DIN R	GR	781801025
WH	DIN R	STWH	781801026
WH	DIN R	STBL	781801027
WH	DIN R	STLT	781801028
BL	DIN L	MR	781801029
BL	DIN L	WH	781801030
BL	DIN L	BL	781801031
BL	DIN L	GR	781801032
BL	DIN L	STWH	781801033
BL	DIN L	STBL	781801034
BL	DIN L	STLT	781801035
BL	DIN R	MR	781801036
BL	DIN R	WH	781801037
BL	DIN R	BL	781801038
BL	DIN R	GR	781801039
BL	DIN R	STWH	781801040
BL	DIN R	STBL	781801041
BL	DIN R	STLT	781801042
GR	DIN L	MR	781801043
GR	DIN L	WH	781801044
GR	DIN L	BL	781801045
GR	DIN L	GR	781801046
GR	DIN L	STWH	781801047
GR	DIN L	STBL	781801048
GR	DIN L	STLT	781801049
GR	DIN R	MR	781801050
GR	DIN R	WH	781801051
GR	DIN R	BL	781801052
GR	DIN R	GR	781801053
GR	DIN R	STWH	781801054
GR	DIN R	STBL	781801055
GR	DIN R	STLT	781801056

P.PWD 600/15 cm

Typ oceli Steel grade Stahlsorte Тип стали	Otevirání Opening Türöffnung Открывание	Sklo Glass Glas Стекло	Kód Code Code Код
SB	DIN L	MR	781802001
SB	DIN L	WH	781802002
SB	DIN L	BL	781802003
SB	DIN L	GR	781802004
SB	DIN L	STWH	781802005
SB	DIN L	STBL	781802006
SB	DIN L	STLT	781802007
SB	DIN R	MR	781802008
SB	DIN R	WH	781802009
SB	DIN R	BL	781802010
SB	DIN R	GR	781802011
SB	DIN R	STWH	781802012
SB	DIN R	STBL	781802013
SB	DIN R	STLT	781802014
WH	DIN L	MR	781802015
WH	DIN L	WH	781802016
WH	DIN L	BL	781802017
WH	DIN L	GR	781802018
WH	DIN L	STWH	781802019
WH	DIN L	STBL	781802020
WH	DIN L	STLT	781802021
WH	DIN R	MR	781802022
WH	DIN R	WH	781802023
WH	DIN R	BL	781802024
WH	DIN R	GR	781802025
WH	DIN R	STWH	781802026
WH	DIN R	STBL	781802027
WH	DIN R	STLT	781802028
BL	DIN L	MR	781802029
BL	DIN L	WH	781802030
BL	DIN L	BL	781802031
BL	DIN L	GR	781802032
BL	DIN L	STWH	781802033
BL	DIN L	STBL	781802034
BL	DIN L	STLT	781802035
BL	DIN R	MR	781802036
BL	DIN R	WH	781802037
BL	DIN R	BL	781802038
BL	DIN R	GR	781802039
BL	DIN R	STWH	781802040
BL	DIN R	STBL	781802041
BL	DIN R	STLT	781802042
GR	DIN L	MR	781802043
GR	DIN L	WH	781802044
GR	DIN L	BL	781802045
GR	DIN L	GR	781802046
GR	DIN L	STWH	781802047
GR	DIN L	STBL	781802048
GR	DIN L	STLT	781802049
GR	DIN R	MR	781802050
GR	DIN R	WH	781802051
GR	DIN R	BL	781802052
GR	DIN R	GR	781802053
GR	DIN R	STWH	781802054
GR	DIN R	STBL	781802055
GR	DIN R	STLT	781802056

P.PWD 900/10 cm

Typ oceli Steel grade Stahlsorte Тип стали	Otevirání Opening Türöffnung Открывание	Sklo Glass Glas Стекло	Kód Code Code Код
SB	DIN L	MR	781901001
SB	DIN L	WH	781901002
SB	DIN L	BL	781901003
SB	DIN L	GR	781901004
SB	DIN L	STWH	781901005
SB	DIN L	STBL	781901006
SB	DIN L	STLT	781901007
SB	DIN R	MR	781901008
SB	DIN R	WH	781901009

P.PWD 900/10 cm

Typ oceli Steel grade Stahlsorte Тип стали	Otevirání Opening Türöffnung Открывание	Sklo Glass Glas Стекло	Kód Code Code Код
SB	DIN R	BL	781901010
SB	DIN R	GR	781901011
SB	DIN R	STWH	781901012
SB	DIN R	STBL	781901013
SB	DIN R	STLT	781901014
WH	DIN L	MR	781901015
WH	DIN L	WH	781901016
WH	DIN L	BL	781901017
WH	DIN L	GR	781901018
WH	DIN L	STWH	781901019
WH	DIN L	STBL	781901020
WH	DIN L	STLT	781901021
WH	DIN R	MR	781901022
WH	DIN R	WH	781901023
WH	DIN R	BL	781901024
WH	DIN R	GR	781901025
WH	DIN R	STWH	781901026
WH	DIN R	STBL	781901027
WH	DIN R	STLT	781901028
BL	DIN L	MR	781901029
BL	DIN L	WH	781901030
BL	DIN L	BL	781901031
BL	DIN L	GR	781901032
BL	DIN L	STWH	781901033
BL	DIN L	STBL	781901034
BL	DIN L	STLT	781901035
BL	DIN R	MR	781901036
BL	DIN R	WH	781901037
BL	DIN R	BL	781901038
BL	DIN R	GR	781901039
BL	DIN R	STWH	781901040
BL	DIN R	STBL	781901041
BL	DIN R	STLT	781901042
GR	DIN L	MR	781901043
GR	DIN L	WH	781901044
GR	DIN L	BL	781901045
GR	DIN L	GR	781901046
GR	DIN L	STWH	781901047
GR	DIN L	STBL	781901048
GR	DIN L	STLT	781901049
GR	DIN R	MR	781901050
GR	DIN R	WH	781901051
GR	DIN R	BL	781901052
GR	DIN R	GR	781901053
GR	DIN R	STWH	781901054
GR	DIN R	STBL	781901055
GR	DIN R	STLT	781901056

P.PWD 900/15 cm

Typ oceli Steel grade Stahlsorte Тип стали	Otevirání Opening Türöffnung Открывание	Sklo Glass Glas Стекло	Kód Code Code Код
SB	DIN L	MR	781902001
SB	DIN L	WH	781902002
SB	DIN L	BL	781902003
SB	DIN L	GR	781902004
SB	DIN L	STWH	781902005
SB	DIN L	STBL	781902006
SB	DIN L	STLT	781902007
SB	DIN R	MR	781902008
SB	DIN R	WH	781902009
SB	DIN R	BL	781902010
SB	DIN R	GR	781902011
SB	DIN R	STWH	781902012
SB	DIN R	STBL	781902013
SB	DIN R	STLT	781902014
WH	DIN L	MR	781902015
WH	DIN L	WH	781902016
WH	DIN L	BL	781902017
WH	DIN L	GR	781902018
WH	DIN L	STWH	781902019

P.PWD 900/15 cm

Typ oceli Steel grade Stahlsorte Тип стали	Otevirání Opening Türöffnung Открывание	Sklo Glass Glas Стекло	Kód Code Code Код
WH	DIN L	STBL	781902020
WH	DIN L	STLT	781902021
WH	DIN R	MR	781902022
WH	DIN R	WH	781902023
WH	DIN R	BL	781902024
WH	DIN R	GR	781902025
WH	DIN R	STWH	781902026
WH	DIN R	STBL	781902027
WH	DIN R	STLT	781902028
BL	DIN L	MR	781902029
BL	DIN L	WH	781902030
BL	DIN L	BL	781902031
BL	DIN L	GR	781902032
BL	DIN L	STWH	781902033
BL	DIN L	STBL	781902034
BL	DIN L	STLT	781902035
BL	DIN R	MR	781902036
BL	DIN R	WH	781902037
BL	DIN R	BL	781902038
BL	DIN R	GR	781902039
BL	DIN R	STWH	781902040
BL	DIN R	STBL	781902041
BL	DIN R	STLT	781902042
GR	DIN L	MR	781902043
GR	DIN L	WH	781902044
GR	DIN L	BL	781902045
GR	DIN L	GR	781902046
GR	DIN L	STWH	781902047
GR	DIN L	STBL	781902048
GR	DIN L	STLT	781902049
GR	DIN R	MR	781902050
GR	DIN R	WH	781902051
GR	DIN R	BL	781902052
GR	DIN R	GR	781902053
GR	DIN R	STWH	781902054
GR	DIN R	STBL	781902055
GR	DIN R	STLT	781902056

Montážní rám pro osazení modulu

Concealed mounting frame

Unterputz Einbaurahmen

Монтажная рама для установки модуля

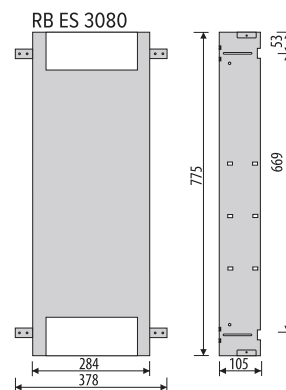
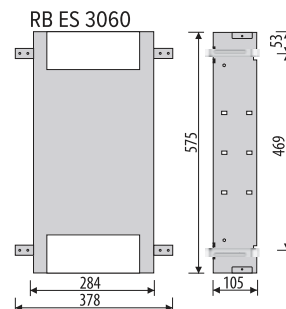
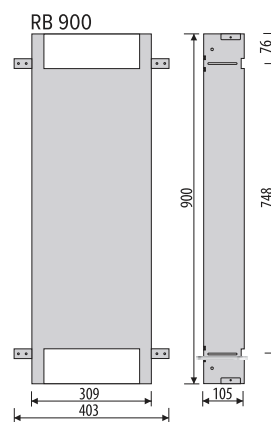
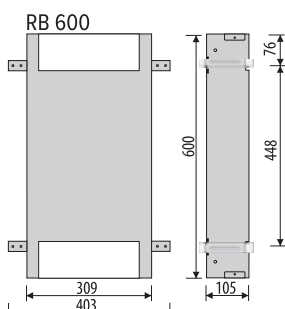
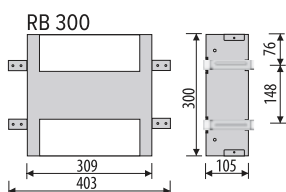

Montážní Rám
Mounting Frame
Einbaurahmen
Монтажная рама

Kód
Code
Code
Code

RB 300	789290101
RB 600	789290102
RB 900	789290103
RB ES 3060	789290104
RB ES 3080	789290105
RBD 200	789290106
RBD 300	789290107
RBD 600	789290108
RBD 900	789290109

Montage: VERTICAL/ HORIZONTAL

Montage: VERTICAL/ HORIZONTAL

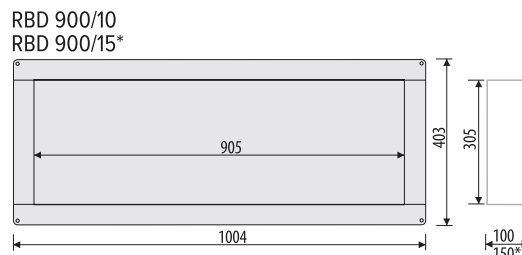
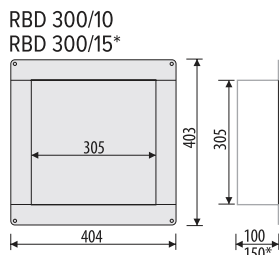
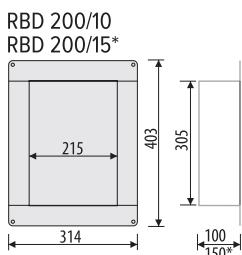

Typy skla

Types of glass doors

Arten von Glastüren

Виды стекла

Mirror

MR

White glossy

WH

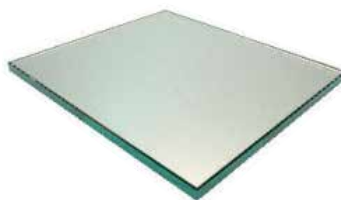

Grey glossy

GR

Black glossy

BL

White satin

ATWH



Latte satin

STLT

Black satin

STBL

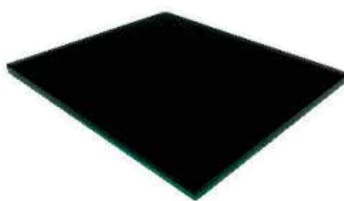
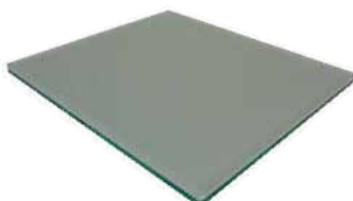

Katalogy Bemeta

Catalogues Bemeta
Bemeta Ergänzungskataloge
каталоги Bemeta

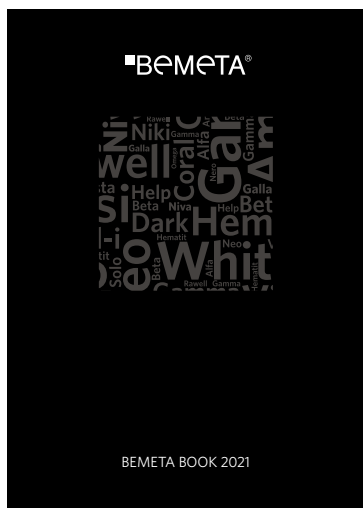

Změny produktů, cen, designu a informací vyhrazeny.
Informace a zobrazení odpovídají době vydání katalogu.
Za tiskové chyby neručíme.

Changes in products, prices, design and informations reserved.
Informations and images are corresponding to the time of the catalog
publication.

Änderungen an Produkten, Preisen, Design und Informationen vorbehalten.
Informationen und Ansichten entsprechen dem Zeitpunkt der Ausgabe vom
Katalog. Für Druckfehler tragen wir keine Verantwortung.

Производитель оставляет за собой право изменять дизайн и стоимость
продукции.
Вся указанная информация и фотографии продукции соответствуют
на дату выпуска каталога.

■ BEMETA

BEMETA DESIGN s. r. o.
Žatčany 28, 664 53, Czech Republic
tel.: +420 544 224 338, gsm: +420 739 201 806

www.bemeta.cz